

# SG 3840

---

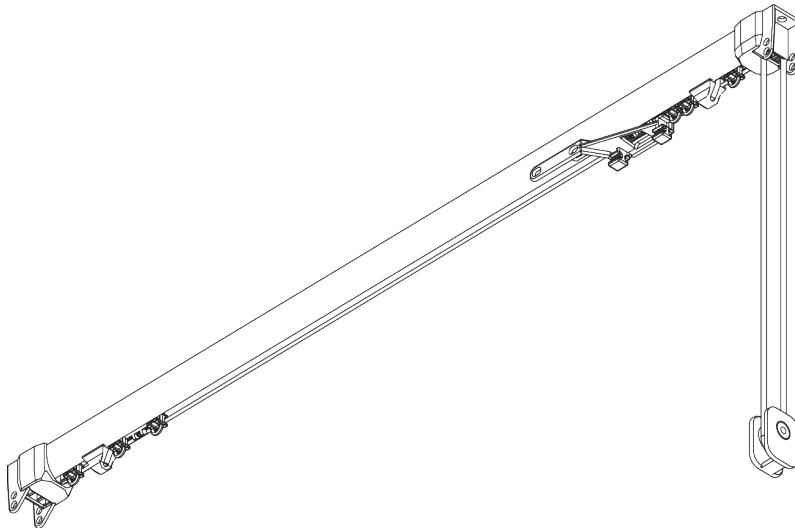
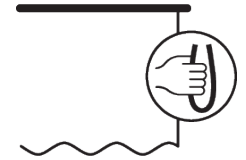

## INFORMAZIONI SUL PRODOTTO

- **Movimentazione:** corda
- **Range:** M - L
- **Fissaggio:** soffitto, parete
- **Finiture:** verniciato bianco RAL 9016, verniciato nero RAL 9005 e anodizzato argento, altri RAL su richiesta
- **Tessuti:** Silent Gliss Collection

### **Caratteristiche:**

- Tecnologia con scivolo a pattino a 2 componenti (2C)
- Wave (2C)
- Curvabile in piano

# SPECIFICHE DEL SISTEMA

## A. DIMENSIONI DEL SISTEMA



6 m



14 kg

### Peso massimo della tenda - Scivolo 2C

	2 m	4 m	6 m
	12	11	10
	14	13	12
	9	8	7
	10	9	6
	6	5	4
	7	6	5
	5	4	3
	6	5	4

(kg max.)

### Peso massimo della tenda - Scivolo a pattino Wave 2C

	2 m	4 m	6 m
	5	8	7
	5	8	8
	5	6	5
	5	6	6
	4	3	-
	4	4	3
	3	2	-
	3	3	-

(kg max.)

## B. PROFILO

Profilo e informazioni di curvatura

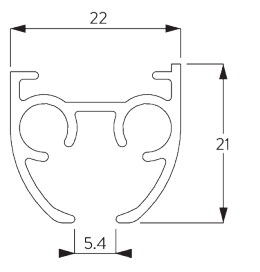

**SG 3841**

Profilo

Raggio:  
20 cm, >30 cm

## C. MISURE

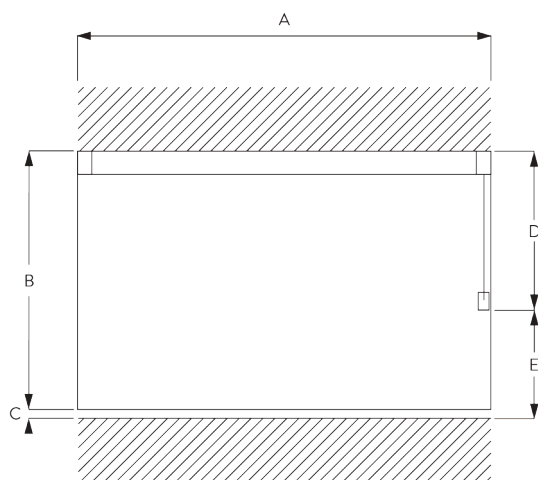

A: Larghezza del sistema

B: Altezza del sistema

C: Distanza del tessuto dal pavimento

D: Altezza corda

E: Dispositivo di sicurezza SG 10731 min. 150 cm da terra

# INSTALLAZIONE

## A. INFORMAZIONI DI FISSAGGIO

Per maggiori dettagli sul fissaggio, visita il sito web [Silent Gliss](http://SilentGliss.com).

Punti di fissaggio

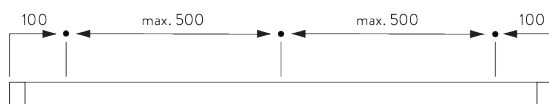

## B. INSTALLAZIONE A SOFFITTO

Supporto girevole SG 3825

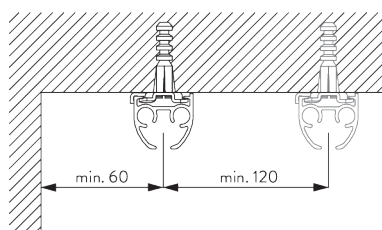

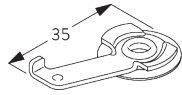

**SG 3825**

Supporto girevole

### Supporto SG 3832

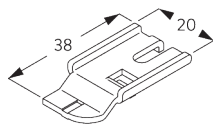
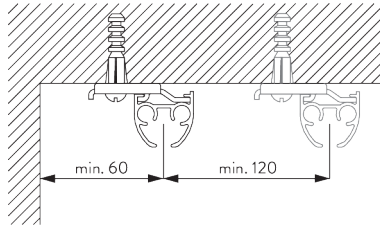

**SG 3832**

Supporto per mensola

### Supporto SG 3826

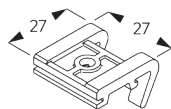
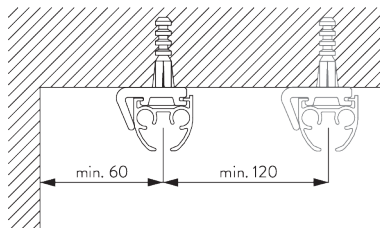

**SG 3826**

Supporto a soffitto

## C. INSTALLAZIONE A

### PARETE

#### Smart Fix

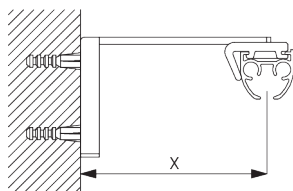

**Smart Fix SG 11200 - SG 11205 e supporto SG 3826:**  
Necessaria vite SG 10492 (M4x8).

Smart Fix	X mm (SG 3826 / SG 3825)	X mm (SG 3832)
SG 11200 / SG 11210	52	70
SG 11201 / SG 11211	72	90
SG 11202 / SG 11212	92	110
SG 11203 / SG 11213	112	130
SG 11204 / SG 11214	142	160
SG 11205 / SG 11215	192	210
SG 11154	102-130	120-148
SG 11155	132-160	150-178
SG 11156	182-210	200-228

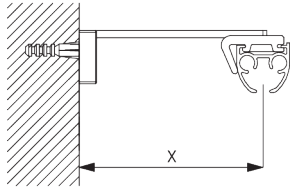

**Smart Fix squadrato SG 11210 - SG 11215 e supporto SG 3826:**  
Necessaria vite SG 10492 (M4x8).

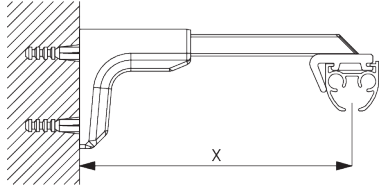

**Smart Fix universale SG 11154 - SG 11156 e supporto SG 3826:**  
Necessaria vite SG 10277 (M4x12).

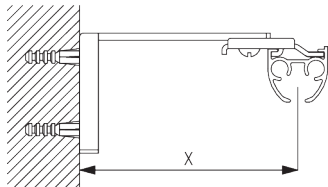

**Smart Fix SG 11200 - SG 11205 e supporto SG 3832:**  
Necessaria vite SG 10492 (M4x8).

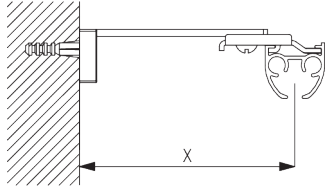

**Smart Fix squadrato SG 11210 - SG 11215 e supporto SG 3832:**  
Necessaria vite SG 10492 (M4x8).

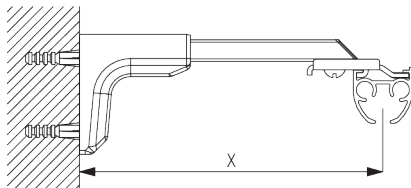

**Smart Fix universale SG 11154 - SG 11156 e supporto SG 3832:**  
Necessaria vite SG 10407 (M4x10).

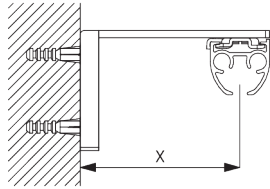

**Smart Fix SG 11200 - SG 11205 e supporto SG 3825:**  
Necessaria vite SG 10074 (M4x8).

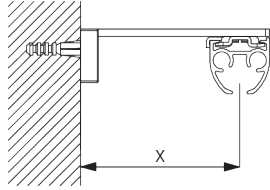

**Smart Fix squadrato SG 11210 - SG 11215 e  
supporto girevole SG 3825:**  
Necessaria vite SG 10074 (M4x8).

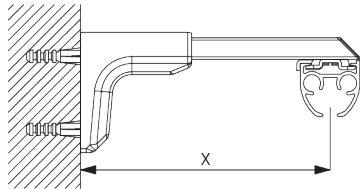

**Smart Fix universale SG 11154 - SG 11156 e  
supporto SG 3825:**  
Necessaria vite SG 11158 (M4x12).

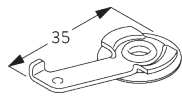

**SG 3825**  
Supporto girevole

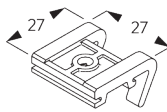

**SG 3826**  
Supporto a soffitto

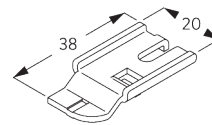

**SG 3832**  
Supporto per mensole



**SG 10074**  
Vite a testa svasata M4x8



**SG 10277**  
Vite a testa cilindrica M4x12



**SG 10407**  
Vite a testa cilindrica M4x10



**SG 10492**  
Vite a testa cilindrica M4x8



**SG 11158**  
Vite a testa svasata M4x12

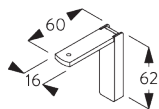

**SG 11200**  
Smart Fix 60 mm

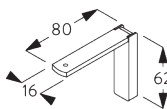

**SG 11201**  
Smart Fix 80 mm

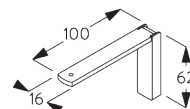

**SG 11202**  
Smart Fix 100 mm

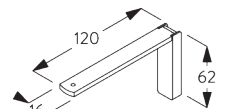

**SG 11203**  
Smart Fix 120 mm

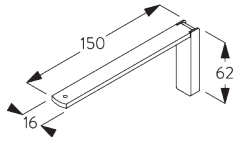

**SG 11204**  
Smart Fix 150 mm

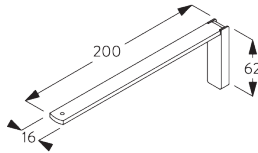

**SG 11205**  
Smart Fix 200 mm

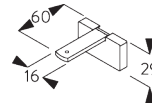

**SG 11210**  
Smart Fix squadrato 60 mm

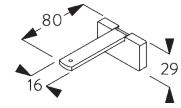

**SG 11211**  
Smart Fix squadrato 80 mm

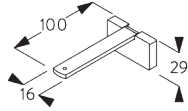

**SG 11212**  
Smart Fix squadrato 100 mm

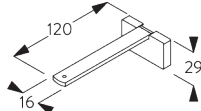

**SG 11213**  
Smart Fix squadrato 120 mm

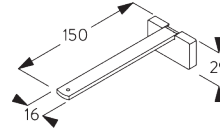

**SG 11214**  
Smart Fix squadrato 150 mm

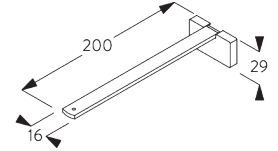

**SG 11215**  
Smart Fix squadrato 200 mm

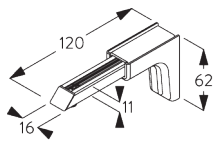

**SG 11154**  
Smart fix universale 120 mm

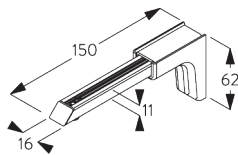

**SG 11155**  
Smart fix universale 150 mm

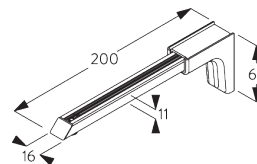

**SG 11156**  
Smart fix universale 200 mm

## Supporto SG 3836

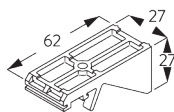
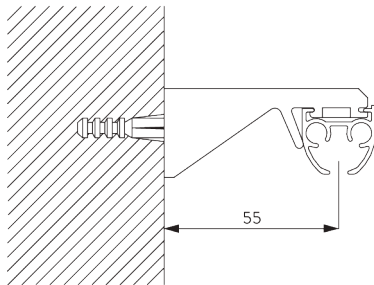

**SG 3836**  
Supporto a parete 62 mm

# OPZIONI DI SISTEMA

## A. WAVE

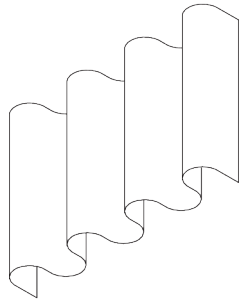

SG 11295

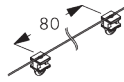

SG 11302

### Componenti standard:

- SG 11295 Vite di arresto
- SG 11302 Scivolo a pattino Wave 2C 80 mm

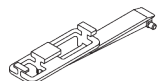

SG 6364



SG 6365

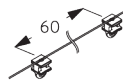

SG 11303

### Componenti opzionali (raggio min: >30 cm):

- SG 6364 Estensione Wave
- SG 6365 Gancio Wave
- SG 11303 Scivolo a pattino Wave 2C 60 mm



SG 3582

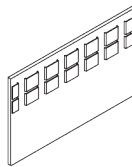

SG 6349

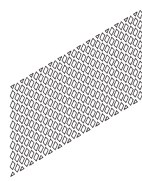

SG 6363

### Componenti per tende:

- SG 3582 Gancio
- SG 6349 Fettuccia tenda Wave
- SG 6363 Fettuccia metallo Wave
- SG 10075 Peso in piombo 50 gr/m
- SG 10076 Peso in tessuto

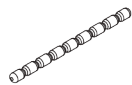

SG 10075



SG 10076

Wave: ingombro tenda impacchettata (componenti standard)

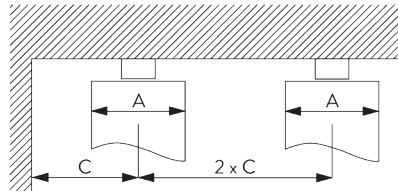
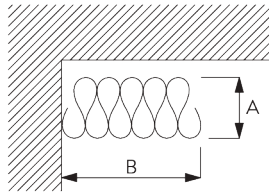

A = Ingombro in profondità  
B = Ingombro in larghezza  
C = Min. distanza

Scivoli rullo/pattino SG 11302	Tasche tra i ganci	Ricchezza tenda approx.	Ingombro in profondità A	Ingombro in larghezza B*	Min. distanza C
80	6	~2.1	140	180 per metro di sistema	90
80	7	~2.3	160	180 per metro di sistema	100

Scivoli rullo/pattino SG 11303	Tasche tra i ganci	Ricchezza tenda approx.	Ingombro in profondità A	Ingombro in larghezza B*	Min. distanza C
60	4	~2.1	100	230 per metro di sistema	70
60	5	~2.3	120	230 per metro di sistema	80

*\*Tenda impacchettata standard B*







- apertura laterale = + 130 mm (per sistema)
- apertura centrale = + 30 mm (per lato)

*\*Tenda impacchettata opzionale B*

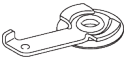

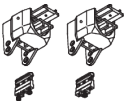
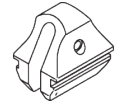

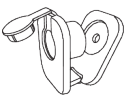







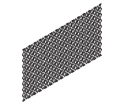

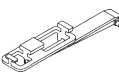

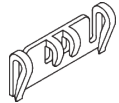
- apertura laterale = + 200 mm (per sistema)
- apertura centrale = + 200 mm (per lato)

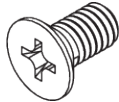
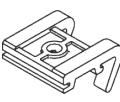
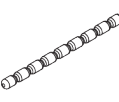
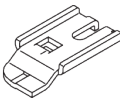
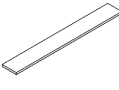
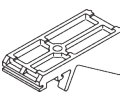
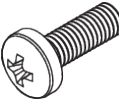
# COMPONENTI

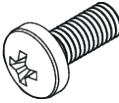
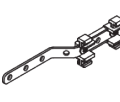
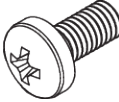
## A. COMPONENTI STANDARD

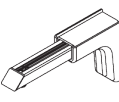
	<b>SG 3090</b> Cordone ø 3 mm
	<b>SG 3825</b> Supporto girevole
	<b>SG 3841</b> Profilo
	<b>SG 3845</b> Set guide diritte
	<b>SG 6086</b> Molla di chiusura
	<b>SG 6288</b> Carrello di sormonto
	<b>SG 10731</b> Set tensionatore child safety
	<b>SG 11300</b> Scivolo 2C

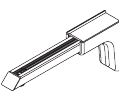
## B. COMPONENTI OPTIONAL

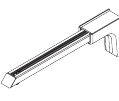
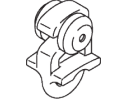
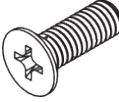
	<b>SG 3340</b> Tendi corda-catenella		<b>SG 6349</b> Fettuccia wave
	<b>SG 3581</b> Gancio		<b>SG 6363</b> Fettuccia termosaldabile
	<b>SG 3582</b> Gancio a G		<b>SG 6364</b> Carrello wave
	<b>SG 3735</b> Tendicordone a parete		<b>SG 6365</b> Gancio wave
	<b>SG 3802</b> Congiunzione		<b>SG 10074</b> Vite a testa svasata M4x8
	<b>SG 3826</b> Supporto a soffitto		<b>SG 10075</b> Piombo 50 g/m
	<b>SG 3832</b> Supporto per mensola		<b>SG 10076</b> Piattina peso
	<b>SG 3836</b> Supporto a parete 62 mm		<b>SG 10277</b> Vite a testa cilindrica M4x12
	<b>SG 6053</b> Fermo a molla		<b>SG 10407</b> Vite a testa cilindrica M4x10
	<b>SG 6063</b> Carrello di sormonto		<b>SG 10492</b> Vite a testa cilindrica M4x8
	<b>SG 6065</b> Arresto con occhio		<b>SG 11154</b> Smart fix universale 120 mm
	<b>SG 6094</b> Scivolo a rullo con gancio in acciaio		<b>SG 11155</b> Smart fix universale 150 mm
	<b>SG 6098</b> Scivolo a rullo con occhio in acciaio		<b>SG 11156</b> Smart fix universale 200 mm
	<b>SG 6283</b> Scivolo a rullo		<b>SG 11158</b> Vite a testa svasata M4x12

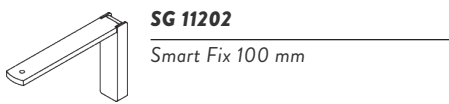
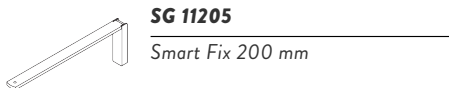
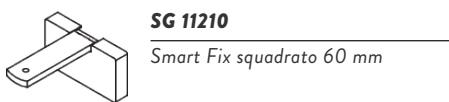
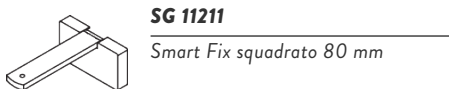
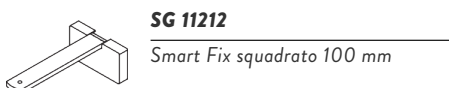
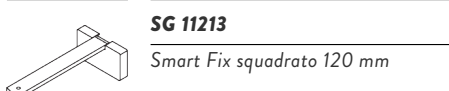
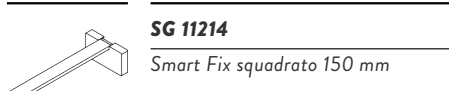
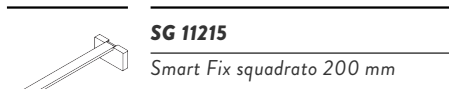
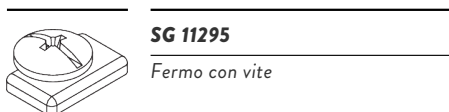
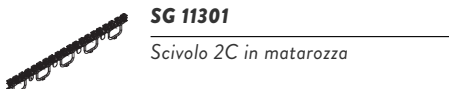
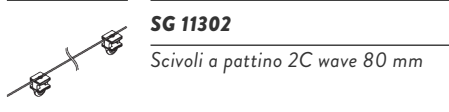
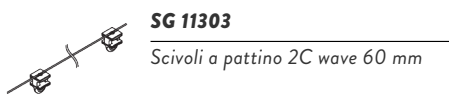
**SG 11200***Smart Fix 60 mm***SG 11201***Smart Fix 80 mm***SG 11202***Smart Fix 100 mm***SG 11203***Smart Fix 120 mm***SG 11204***Smart Fix 150 mm***SG 11205***Smart Fix 200 mm***SG 11210***Smart Fix squadrato 60 mm***SG 11211***Smart Fix squadrato 80 mm***SG 11212***Smart Fix squadrato 100 mm***SG 11213***Smart Fix squadrato 120 mm***SG 11214***Smart Fix squadrato 150 mm***SG 11215***Smart Fix squadrato 200 mm***SG 11295***Fermo con vite***SG 11301***Scivolo 2C in matarozza***SG 11302***Scivoli a pattino 2C wave 80 mm***SG 11303***Scivoli a pattino 2C wave 60 mm*

