

# SG 6103

---

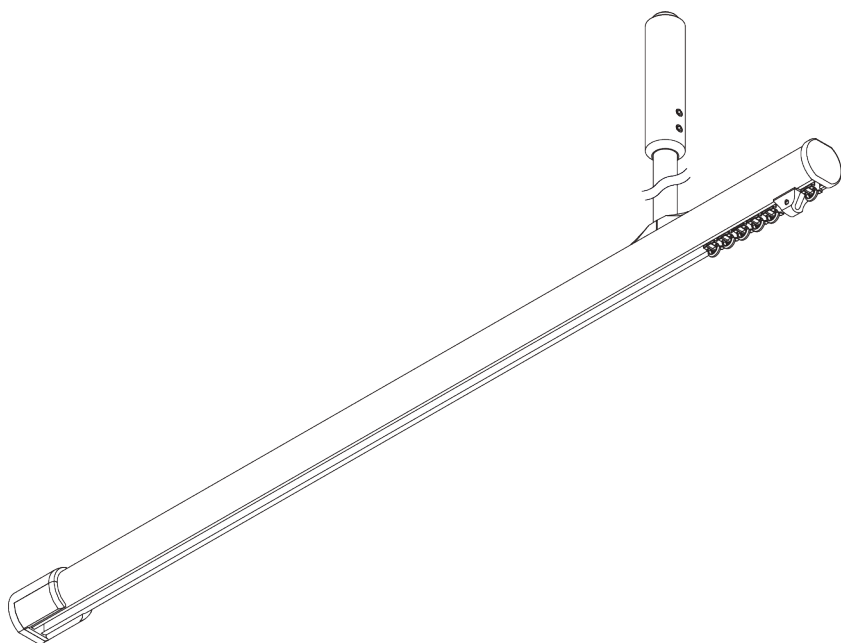
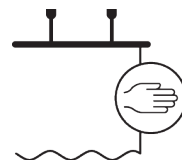

## INFORMAZIONI SUL PRODOTTO

- **Movimentazione:** strappo
- **Range:** S - L
- **Fissaggio:** sospeso, soffitto, parete
- **Finiture:** verniciato bianco RAL 9016 e anodizzato argento, altri RAL su richiesta
- **Tessuti:** Silent Gliss Collection

### **Caratteristiche:**

- Divisore di ambienti universale
- Tecnologia con scivolo a 2 componenti (2C)
- Wave (2C)
- Sospeso
- Diversi layout versatili
- Curvabile in piano

# SPECIFICHE DEL SISTEMA

## A. PROFILO

Profilo e informazioni di curvatura

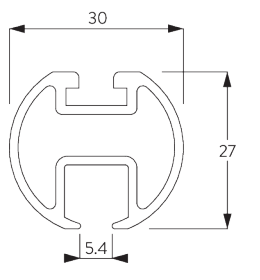

SG 6103p

Profilo

Raggio:  
✓ >25 cm

## B. MISURE

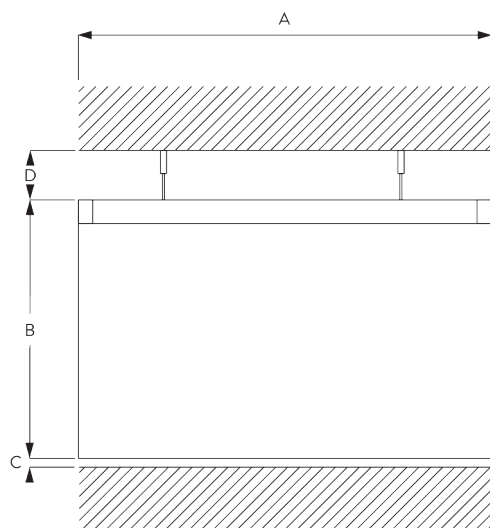

A: Larghezza del sistema

B: Altezza del sistema

C: Distanza del tessuto dal pavimento

D: Distanza del sistema dal soffitto

# INSTALLAZIONE

## A. INFORMAZIONI DI FISSAGGIO

Per informazioni dettagliate a proposito dell'installazione, visita il sito [Silent Gliss](http://SilentGliss.com).

Punti di fissaggio

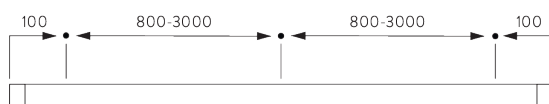

Copertura anti polvere

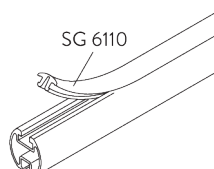

**B. INSTALLAZIONE A  
SOFFITTO**

**Tirante SG 6190 /  
SG 6196**

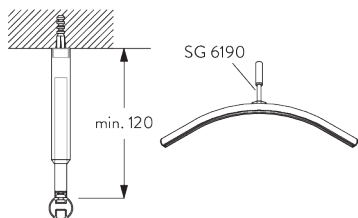

Oppure variante con tirante con doppia manopola SG 6196.

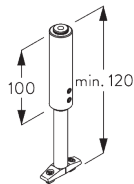

**SG 6190**

*Tirante*

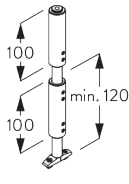

**SG 6196**

*Tirante con doppia manopola*

**Mini tirante SG 6175**

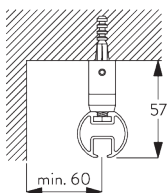

**SG 6175**

*Tirante 3 cm*

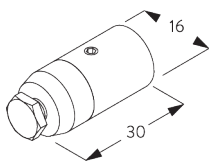

**Supporto SG 6124**

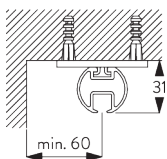

**SG 6124**

*Supporto*

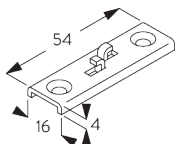

## V-hanger

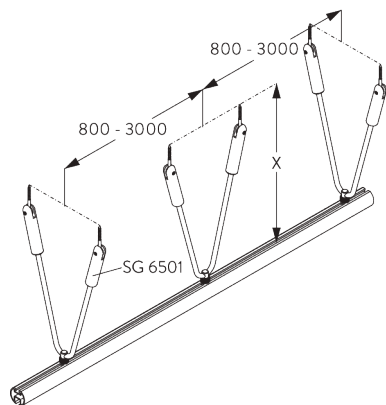

**SG 6501:**  
*I tiranti a V (25°-35°) garantiscono ulteriore stabilità laterale.*

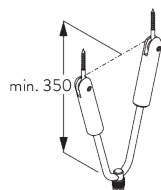

---

**SG 6501**  
*Tirante a V*

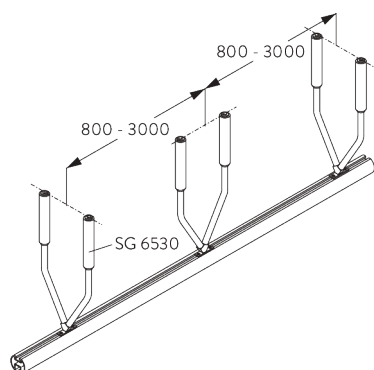

**SG 6530:**  
*Tirante a V (25°-35°) garantiscono ulteriore stabilità laterale.*

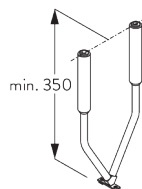

---

**SG 6530**  
*Tirante a V*

**C. INSTALLAZIONE A PARETE**

**Smart Fix**

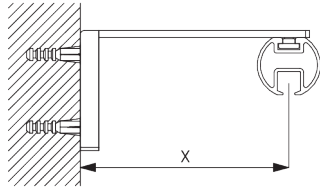

**Smart Fix con asola SG 11206 - SG 11208:**  
Necessaria vite SG 10492 (M4x8).

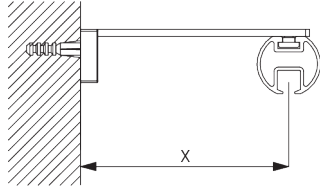

**Smart Fix con asola SG 11216 - SG 11218:**  
Necessaria vite SG 10492 (M4x8).

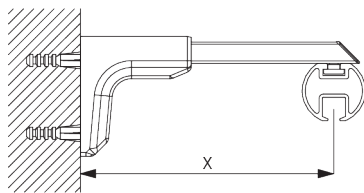

**Smart Fix universale SG 11154 - SG 11156:**  
Necessaria vite SG 11131 (M4x6).

Smart Fix	X mm
SG 11206 / SG 11216	33-51
SG 11207 / SG 11217	53-71
SG 11208 / SG 11218	73-91
SG 11154	102-130
SG 11155	132-160
SG 11156	182-210

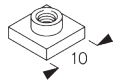

**SG 6117**  
Dado



**SG 10492**  
Vite a testa cilindrica M4x8



**SG 11131**  
Vite a testa cilindrica con flangia M4x6

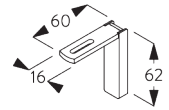

**SG 11206**  
Smart Fix con asola 60 mm

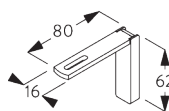

**SG 11207**  
Smart Fix con asola 80 mm

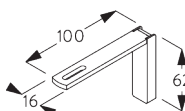

**SG 11208**  
Smart Fix con asola 100 mm

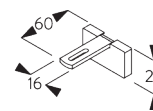

**SG 11216**  
Smart Fix squadrato con asola 60 mm

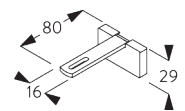

**SG 11217**  
Smart Fix squadrato con asola 80 mm

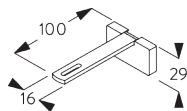

**SG 11218**  
Smart Fix squadrato con asola 100 mm

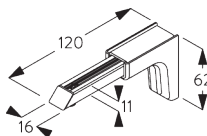

**SG 11154**  
Smart fix universale 120 mm

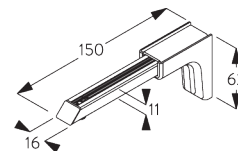

**SG 11155**  
Smart fix universale 150 mm

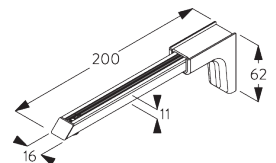

**SG 11156**  
Smart fix universale 200 mm

## D. SUPPORTO A PARETE

### Supporto SG 6620

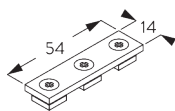
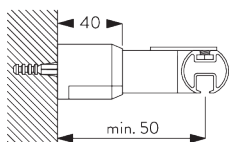

**SG 6123**  
Congiunzione

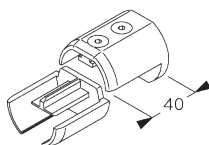

**SG 6620**  
Supporto laterale

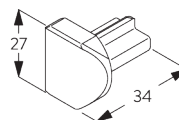

**SG 6631**  
Tappo per incrocio

## E. CONGIUNZIONI TRA PROFILI

### Ponte di congiunzione SG 6521

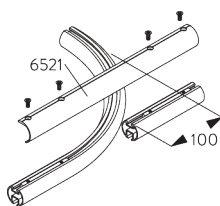
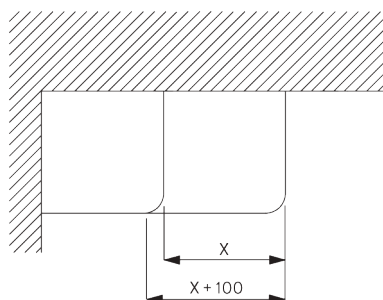

Nota: assicurati di allegare uno schizzo!

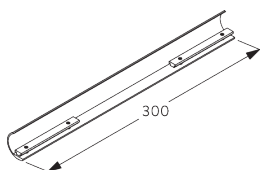

**SG 6521**  
Ponte di congiunzione

### Set di congiunzione SG 6635

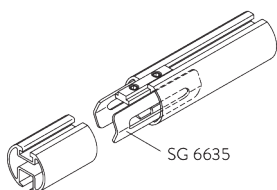

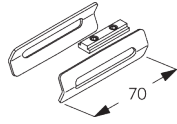

**SG 6635**

Congiunzione interna

# OPZIONI DEL SISTEMA

## A. POSSIBILI LAYOUT

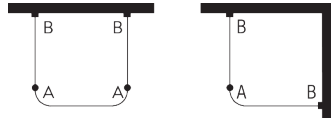

A: Tirante  
B: Supporto a parete

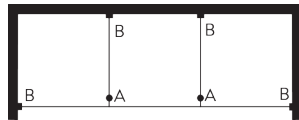

A: Tirante  
B: Supporto a parete

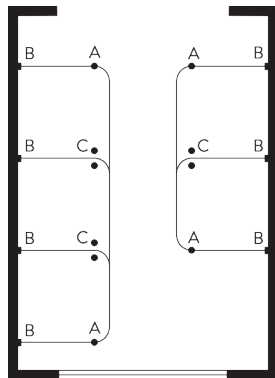

A: Tirante  
B: Supporto a parete  
C: Tirante a V

## B. WAVE

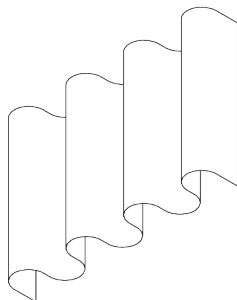

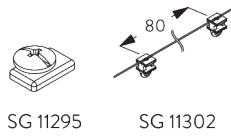

SG 11295

SG 11302

**Componenti standard:**

- SG 11295 Vite di arresto
- SG 11302 Scivolo a pattino Wave 2C 80 mm

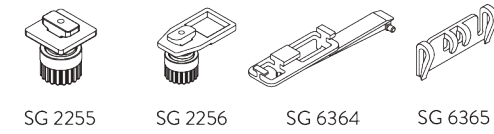

SG 2255

SG 2256

SG 6364

SG 6365

**Componenti opzionali:**

- SG 2255 Freno
- SG 2256 Freno
- SG 6364 Estensione Wave
- SG 6365 Gancio
- SG 6366 Scivolo Wave per asta
- SG 10430-34 Asta
- SG 11303 Scivolo a pattino Wave 2C 60 mm



SG 6366

SG 10430-34

SG 11303

**Componenti per tende:**

- SG 3582 Gancio
- SG 6349 Fettuccia tessuto Wave
- SG 6363 Fettuccia termosaldabile Wave
- SG 10075 Peso in piombo 50 gr/m
- SG 10076 Piattina peso

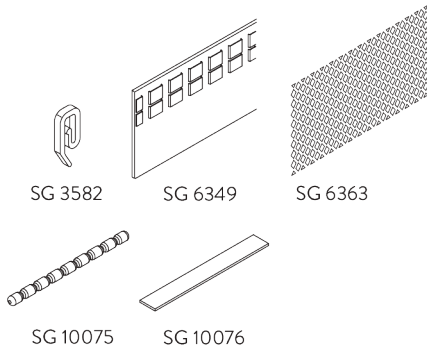

SG 3582

SG 6349

SG 6363

SG 10075

SG 10076

Wave: ingombro tenda impacchettata (componenti standard)

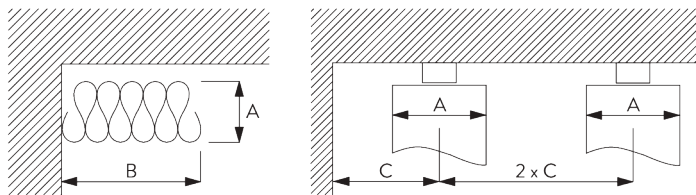

A = Ingombro in profondità  
B = Ingombro in larghezza  
C = Min. distanza

Scivoli rullo/pattino SG 11302	Tasche tra i ganci	Ricchezza tenda approx.	Ingombro in profondità A	Ingombro in larghezza B*	Min. distanza C
80	6	~2.1	140	180 per metro di sistema	90
80	7	~2.3	160	180 per metro di sistema	100

Scivoli rullo/pattino SG 11303	Tasche tra i ganci	Ricchezza tenda approx.	Ingombro in profondità A	Ingombro in larghezza B*	Min. distanza C
60	4	~2.1	100	230 per metro di sistema	70
60	5	~2.3	120	230 per metro di sistema	80

\*La dimensione della pila B quando si utilizza il braccio di prolunga opzionale SG 6364 aumenta di 150 mm per pila di tende!



# COMPONENTI

## A. COMPONENTI STANDARD



**SG 6065**  
Arresto con occhio

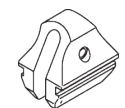

**SG 6086**  
Molla di chiusura



**SG 6103p**  
Profilo

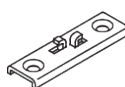

**SG 6124**  
Supporto

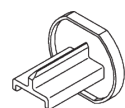

**SG 6630**  
Tappo profilo



**SG 11300**  
Scivolo 2C

## B. COMPONENTI OPTIONAL

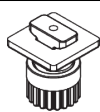

**SG 2255**  
Freno

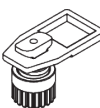

**SG 2256**  
Freno



**SG 3582**  
Gancio a G



**SG 6053**  
Fermo a molla



**SG 6094**  
Scivolo a rullo con gancio in acciaio



**SG 6098**  
Scivolo a rullo con occhio in acciaio



**SG 6110**  
Copriprofilo PVC

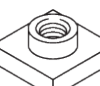

**SG 6117**  
Dado

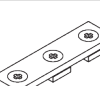

**SG 6123**  
Congiunzione

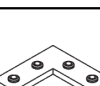

**SG 6125**  
Congiunzione per angolo



**SG 6175**  
Tirante 3 cm

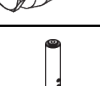

**SG 6190**  
Tirante

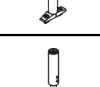

**SG 6196**  
Tirante con doppia manopola

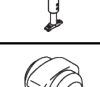

**SG 6283**  
Scivolo a rullo

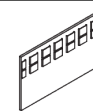

**SG 6349**  
Fettuccia wave

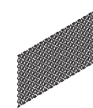

**SG 6363**  
Fettuccia termosaldabile

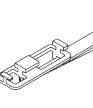

**SG 6364**  
Carrello wave



**SG 6365**  
Gancio wave

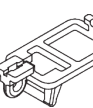

**SG 6366**  
Scivolo pilota wave con aggancio



**SG 6501**  
Tirante a V



**SG 6521**  
Ponte di congiunzione



**SG 6530**  
Tirante a V



**SG 6620**  
Supporto laterale



**SG 6631**  
Tappo per incrocio



**SG 6635**  
Congiunzione interna



**SG 10075**  
Piombo 50 g/m



**SG 10076**  
Piattina peso

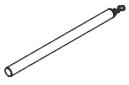
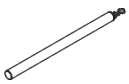
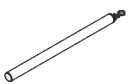
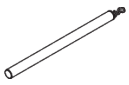
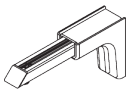
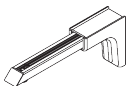
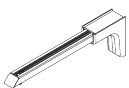
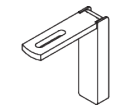
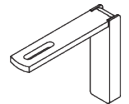
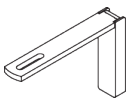
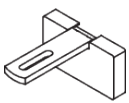
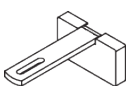
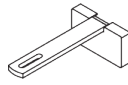
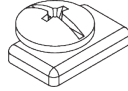
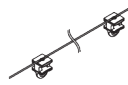
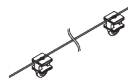

**SG 10430**  
Asta in alluminio 50 cm

**SG 10431***Asta in alluminio 75 cm***SG 10432***Asta in alluminio 100 cm***SG 10433***Asta in alluminio 125 cm***SG 10434***Asta in alluminio 150 cm***SG 10492***Vite a testa cilindrica M4x8***SG 11131***Vite a testa cilindrica con flangia M4x6***SG 11154***Smart fix univernale 120 mm***SG 11155***Smart fix univernale 150 mm***SG 11156***Smart fix univernale 200 mm***SG 11206***Smart Fix con asola 60 mm***SG 11207***Smart Fix con asola 80 mm***SG 11208***Smart Fix con asola 100 mm***SG 11216***Smart Fix squadrato con asola 60 mm***SG 11217***Smart Fix squadrato con asola 80 mm***SG 11218***Smart Fix squadrato con asola 100 mm***SG 11295***Fermo con vite***SG 11301***Scivolo 2C in matarozza***SG 11302***Scivoli a pattino 2C wave 80 mm***SG 11303***Scivoli a pattino 2C wave 60 mm*



