

SG 4710

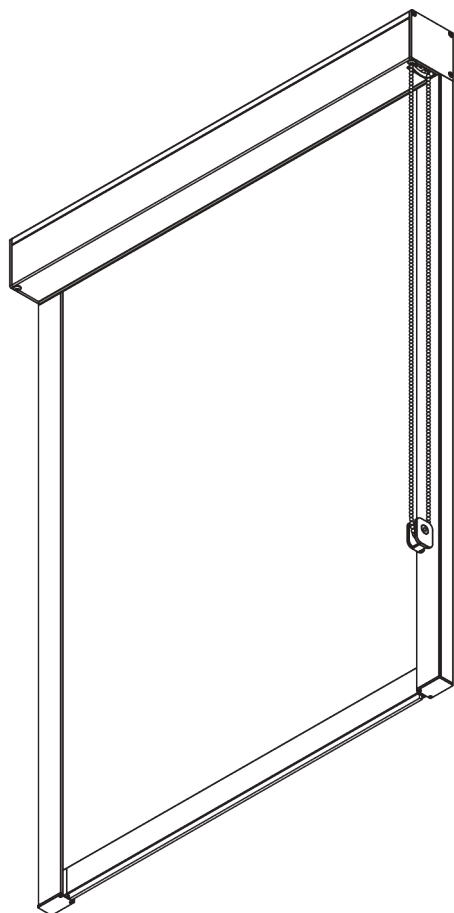
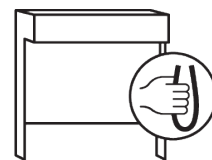

INFORMAZIONI SUL PRODOTTO

- **Movimentazione:** *catenella*
- **Range:** *S*
- **Fissaggio:** *soffitto, parete, incasso*
- **Finiture:** *verniciato bianco RAL 9016 o verniciato nero RAL 9005, altri RAL su richiesta*
- **Tessuti:** *Silent Gliss Collection*

Caratteristiche:

- *Tecnologia Zip*
- *Catenella in acciaio INOX*
- *Frizione 2 a 1*
- *Canale laterale 40 mm, punti di fissaggio pre-forati*

SPECIFICHE DEL SISTEMA

A. DIMENSIONI DEL SISTEMA

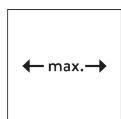

1.6 m

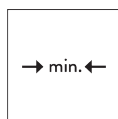

65 cm

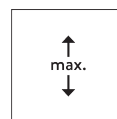

1.6 m

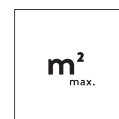

2.5 m²



2 kg

B. PROFILO

Informazioni sul profilo

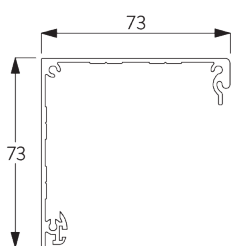

SG 10994

Cassonetto parte fissa 73 mm

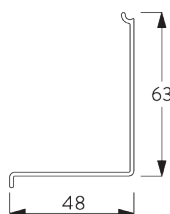

SG 10995

Cover cassonetto 73 mm

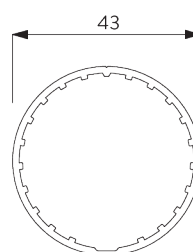

SG 10532

Tubo ø 43 mm

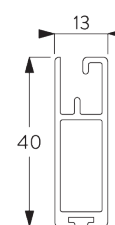

SG 10993

Piattina peso

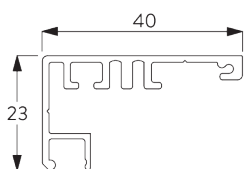

SG 11418

Guida laterale parte fissa



SG 11419

Cover guida laterale

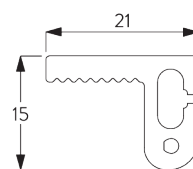

SG 11421

Profilo zip

C. MISURE

Fissaggio nel vano

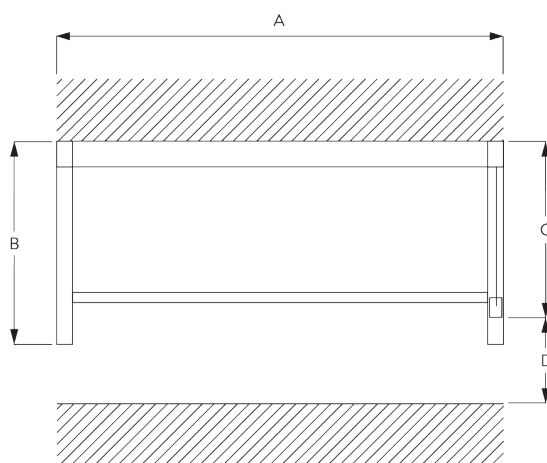

A: Larghezza sistema

B: Altezza sistema

C: Altezza catenella

D: Dispositivo di sicurezza SG 10731 min. 150 cm da terra

Fissaggio frontale

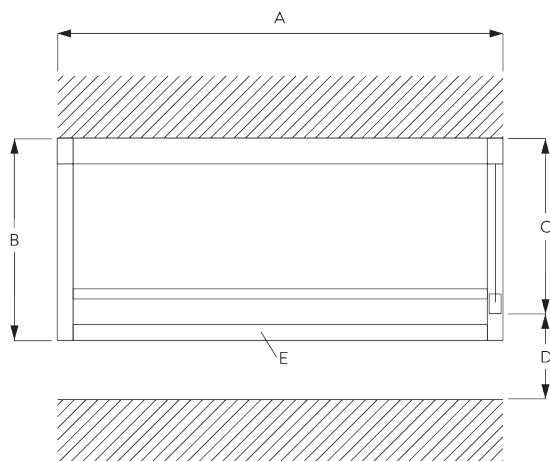

A: Larghezza sistema

B: Altezza sistema

C: Altezza catenella

D: Dispositivo di sicurezza SG 10731 min. 150 cm da terra

E: Optional: profilo di arresto (SG 11418 / SG 11419)

INSTALLAZIONE

A. INFORMAZIONI DI FISSAGGIO

Per informazioni dettagliate a proposito dell'installazione, visita il sito [Silent Gliss](http://SilentGliss.com).

Fissaggio nel vano - punti d fissaggio

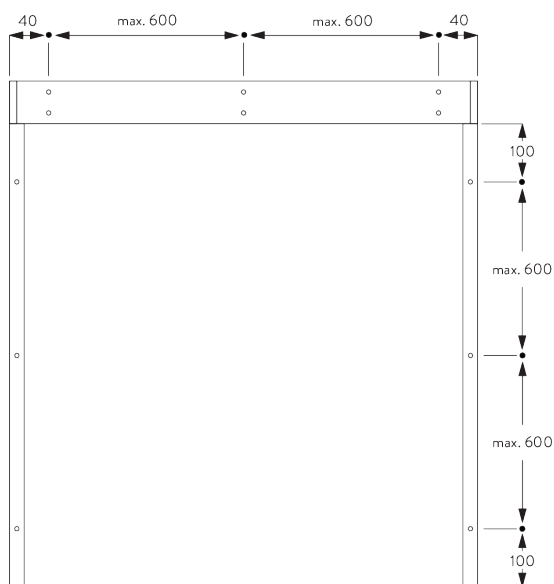

**Fissaggio frontale -
punti di fissaggio**

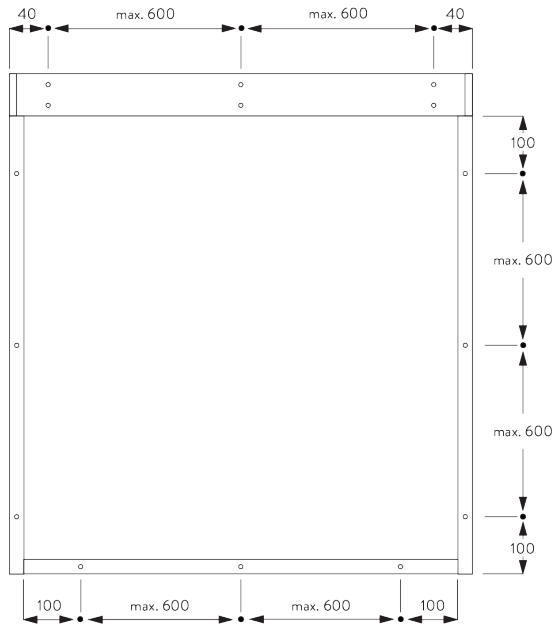

**B. FISSAGGIO A
SOFFITTO**

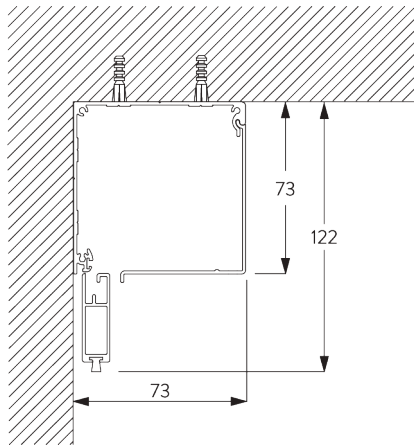

**C. FISSAGGIO A
PARETE**

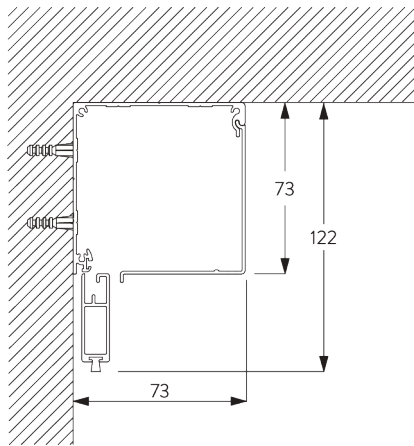

**D. FISSAGGIO A
INCASSO**

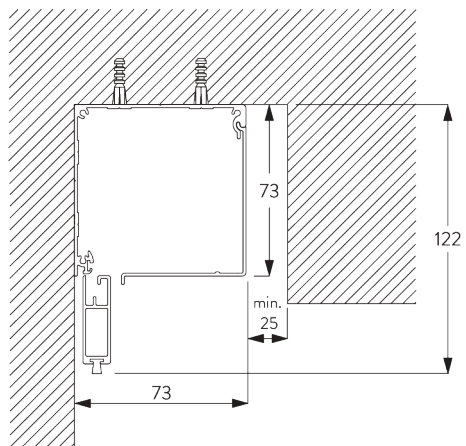

**E. PROFILI LATERALI
SG 11418 / SG 11419**

Fissaggio nel vano

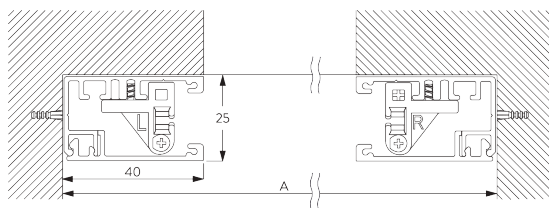

A: Larghezza del sistema



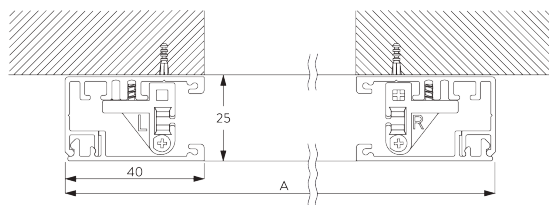







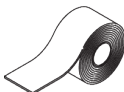
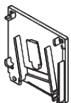
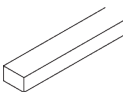
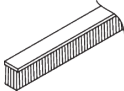

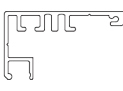
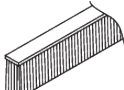
Fissaggio frontale

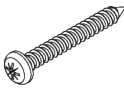
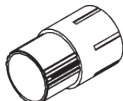
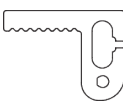
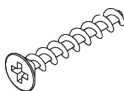
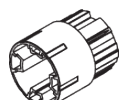
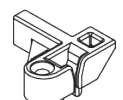

A: Larghezza del sistema

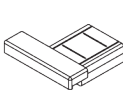
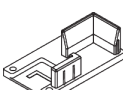
COMPONENTI

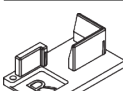
A. COMPONENTI STANDARD

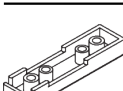
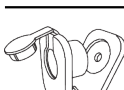
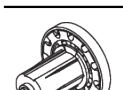
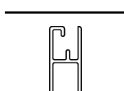
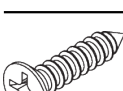
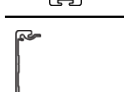
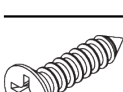
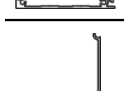
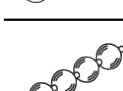
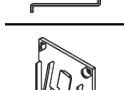
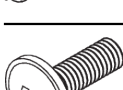
	SG 4226 Biadesivo 30 mm		SG 11005 Tappo destro 73 mm		SG 11060 Nastro adesivo in schiuma
	SG 4508 Spazzolino 5x7 mm		SG 11010 Clip		SG 11418 Guida laterale parte fissa
	SG 4509 Spazzolino 5x12 mm		SG 11011 Clip		SG 11419 Cover guida laterale
	SG 6791 Vite 3.9x32		SG 11014 Adattatore tubo		SG 11421 Profilo zip
	SG 6933 Vite svasata PT KA25x16		SG 11015 Adattatore tubo		SG 11473 Guida zip sinistra
	SG 6936 Vite a testa svasata PT KA22x10		SG 11025 Zip		SG 11474 Guida zip destra
	SG 6942 Vite a testa svasata KA30x8		SG 11028 Tappo sinistra		SG 11475 Tappo guida laterale sinistra
	SG 10532 Tubo ø 43 mm		SG 11029 Tappo destra		SG 11476 Tappo guida laterale destra
	SG 10668 PVC strip 10 mm		SG 11030 Cover		
	SG 10731 Set tensionatore child safety		SG 11031 Comando catenella		
	SG 10993 Piastrina peso		SG 11034 Vite a testa svasata 3,5x16		
	SG 10994 Cassonetto parte fissa 73 mm		SG 11035 Vite a testa svasata 2,2x9.5		
	SG 10995 Cover cassonetto 73 mm		SG 11040 Catenella 4.5 mm		
	SG 11004 Tappo sinistro 73 mm		SG 11059 Vite a testa cilindrica con flangia M4x12		

B. COMPONENTI OPTIONAL

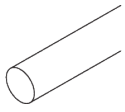

SG 4951

Tondino in acciaio ø 8 mm

