

# SG 5600

---

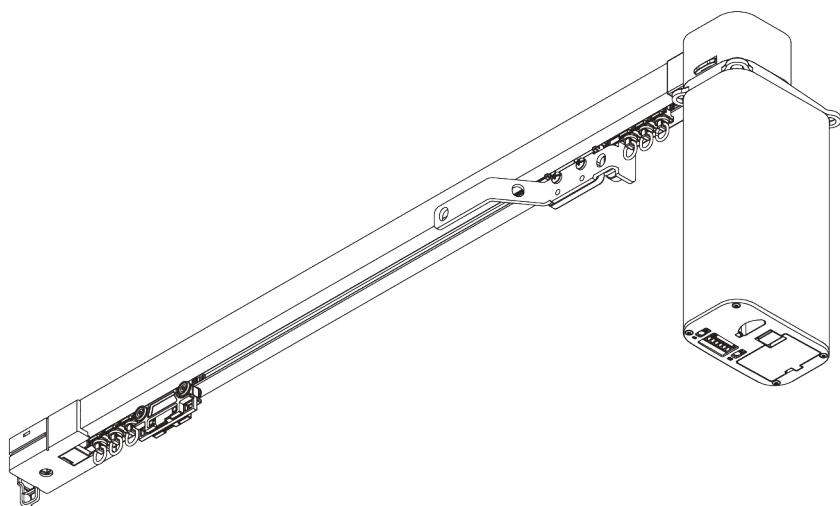
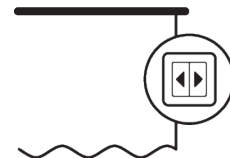

## INFORMAZIONI SUL PRODOTTO

- **Movimentazione:** motore
- **Range:** S - L
- **Fissaggio:** soffitto, parete, incasso
- **Finiture:** verniciato bianco RAL 9016, verniciato nero RAL 9005 o argento anodizzato, altri RAL su richiesta (profilo incasso solo in bianco RAL 9016, verniciato nero RAL 9005 o colore speciale)
- **Tessuti:** Silent Gliss Collection

### **Caratteristiche:**

- Silenzioso, veloce e potente
- Scivoli a rullo bi-componente (2C)
- Wave (2C)
- Varie opzioni di comando
- Touch & Go
- Facile programmazione
- 100-250 AC e/o 24 V DC con lo stesso motore
- Curvabile in piano
- Profilo ad incasso curvabile in piano

# SPECIFICHE DEL SISTEMA

## A. DIMENSIONI DEL SISTEMA

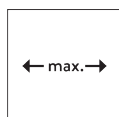

25 m

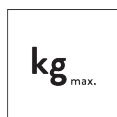

65 kg

### Max. peso della tenda con scivoli a rullo 2C / scivoli a rullo 2C Wave

Fino a 12 m: Touch & Go, movimentazione a strappo, programmazione automatica

	2 m	4 m	6 m	8 m	10 m	12 m	15 m	18 m	21 m	25 m
	25	45	45	50	65	45	45	45	45	40
	25	45	45	50	65	45	45	45	45	40
	25	35	35	40	35	35	35	32	29	25
	25	35	35	40	35	35	35	32	29	25
	25	30	30	30	25	25	22	19	15	-
	25	30	30	30	25	25	22	19	15	-
	20	20	20	18	16	12	10	-	-	-
	20	20	20	18	16	12	10	-	-	-

(kg max.)

### Max. peso della tenda con scivoli a pattino

	2 m	4 m	6 m	8 m	10 m
	20	25	25	25	20
	20	25	25	25	20
	20	20	20	20	15
	20	20	20	20	15
	20	20	20	15	10
	20	20	20	15	10
	20	20	15	8	-
	20	20	15	8	-

(kg max.)

## B. PROFILO

Profilo e informazioni di curvatura

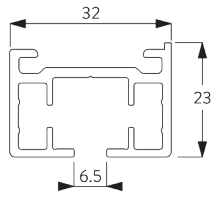

**SG 10850**

Profilo

Raggio:  
✓ >25 cm

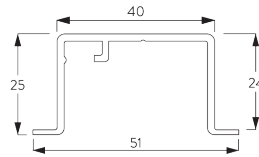

**SG 10862**

Profilo per incasso

Raggio:  
✓ 50 - 75 cm  
>75 cm su richiesta

## C. MISURE

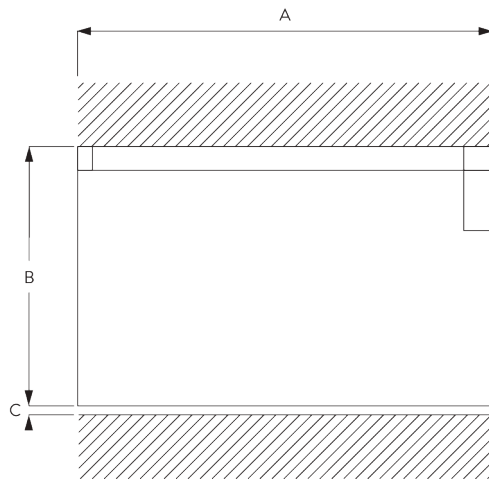

A: Larghezza sistema

B: Altezza sistema

C: Distanza del tessuto dal pavimento

# INSTALLAZIONE

## A. INFORMAZIONI DI FISSAGGIO

Per maggiori dettagli sul fissaggio, visita il sito web [Silent Gliss](http://SilentGliss.com).

Punti di fissaggio

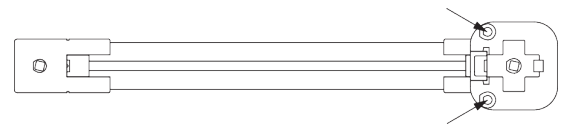
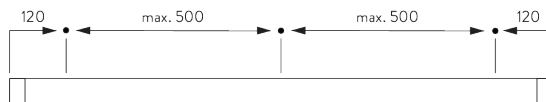

Maschera motore da fissare (solo montaggio a soffitto).

## B. FISSAGGIO A SOFFITTO

Supporti girevoli SG 3004

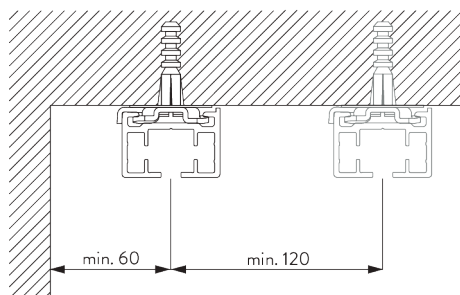

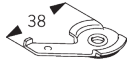

**SG 3004**

Supporto girevole

**Fissaggio diretto (solo con scivoli a rullo 2C)**

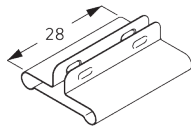
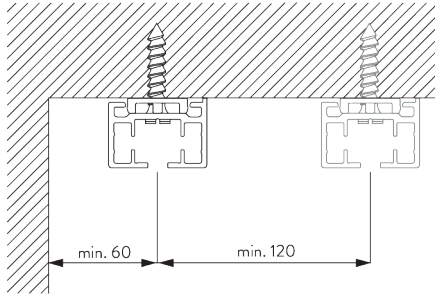

**SG 7002**

Accessorio di protezione profilo

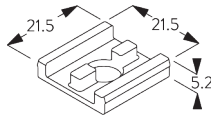

**SG 10865**

Supporto per fissaggio diretto

**C. FISSAGGIO A PARETE**

**Smart Fix**

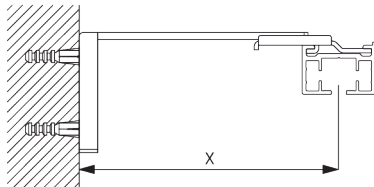

**Smart Fix SG 11200 - SG 11205 e supporti SG 3041:**  
Necessaria vite SG 10492 (M4x8).

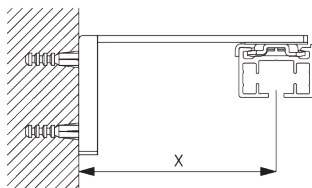

**Smart Fix SG 11200 - SG 11205 e supporti SG 3004:**  
Necessaria vite SG 10074 (M4x8).

Smart Fix	X mm (SG 3041)	X mm (SG 3004)
SG 11200 / SG 11210	83	
SG 11201 / SG 11211	103	72
SG 11202 / SG 11212	123	92
SG 11203 / SG 11213	143	112
SG 11204 / SG 11214	173	142
SG 11205 / SG 11215	223	192
SG 11154	128-156	102-130
SG 11155	158-186	132-160
SG 11156	208-236	182-210

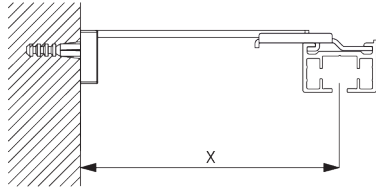

**Smart Fix squadrato SG 11210 - SG 11215 e supporti SG 3041:**

Necessaria vite SG 10492 (M4x8).

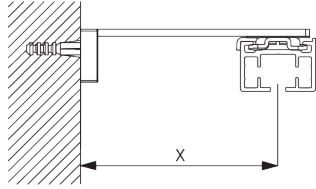

**Smart Fix squadrato SG 11210 - SG 11215 e supporti SG 3004:**

Necessaria vite SG 10074 (M4x8).

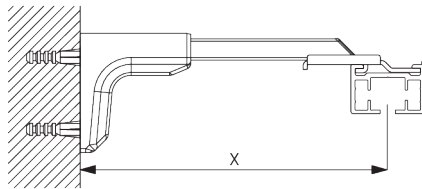

**Smart Fix universale SG 11154 - SG 11156 e supporti SG 3041:**

Necessaria vite SG 10407 (M4x10).

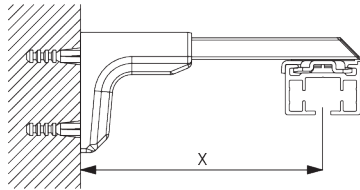

**Smart Fix universale SG 11154 - SG 11156 e supporti girevoli SG 3004:**

Necessaria vite SG 11158 (M4x12).

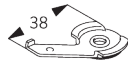

**SG 3004**

Supporto girevole

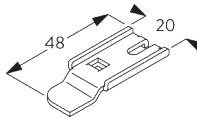

**SG 3041**

Supporto



**SG 10074**

Vite a testa svasata M4x8



**SG 10407**

Vite a testa cilindrica M4x10



**SG 10492**

Vite a testa cilindrica M4x8



**SG 11158**

Vite a testa svasata M4x12

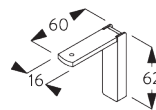

**SG 11200**

Smart Fix 60 mm

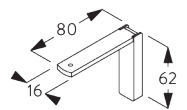

**SG 11201**

Smart Fix 80 mm

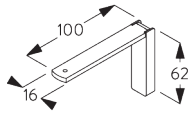

**SG 11202**  
Smart Fix 100 mm

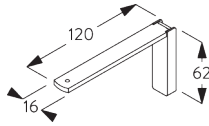

**SG 11203**  
Smart Fix 120 mm

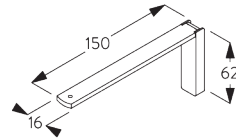

**SG 11204**  
Smart Fix 150 mm

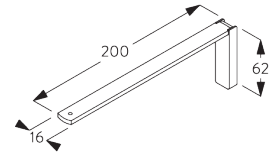

**SG 11205**  
Smart Fix 200 mm

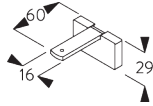

**SG 11210**  
Smart Fix squadrato 60 mm

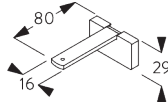

**SG 11211**  
Smart Fix squadrato 80 mm

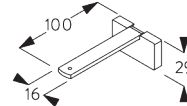

**SG 11212**  
Smart Fix squadrato 100 mm

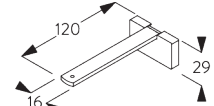

**SG 11213**  
Smart Fix squadrato 120 mm

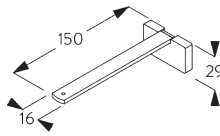

**SG 11214**  
Smart Fix squadrato 150 mm

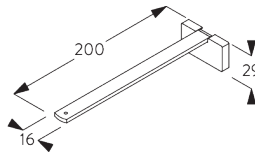

**SG 11215**  
Smart Fix squadrato 200 mm

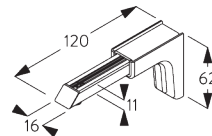

**SG 11154**  
Smart fix universale 120 mm

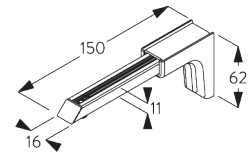

**SG 11155**  
Smart fix universale 150 mm

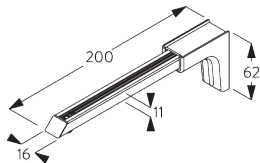

**SG 11156**  
Smart fix universale 200 mm

## D. FISSAGGIO AD INCASSO

### Profilo ad incasso SG 10862

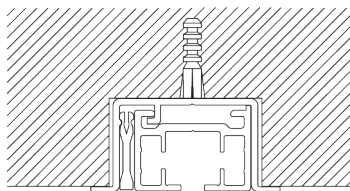

Uno spessore SG 5118 per punto di fissaggio.  
Per maggiori dettagli sul fissaggio, visita il sito web  
Silent Gliss.

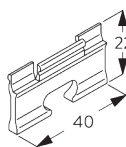

**SG 5118**  
Spessore per incasso

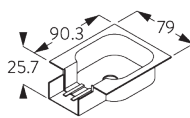

**SG 10863**  
Mascherina per incasso

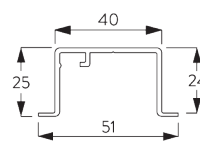

**SG 10862**  
Profilo per incasso

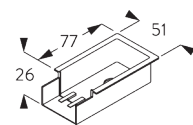

**SG 10864**  
Mascherina per incasso

## Motore incassato nel controsoffitto

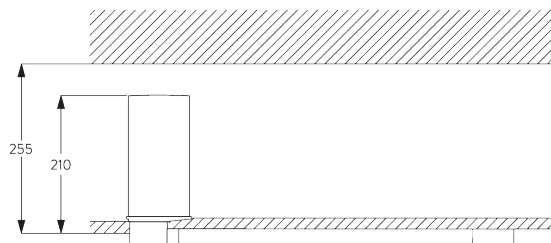

Profilo installato con supporti girevoli SG 3004.

Necessario accesso al controsoffitto per il montaggio del motore e per la programmazione.

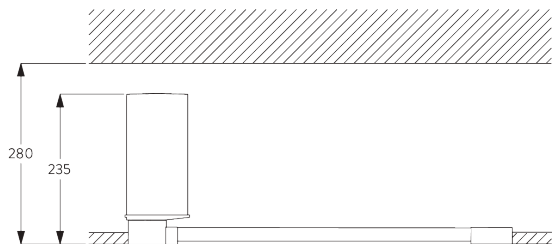

Installazione con profilo ad incasso SG 10862.

Necessario accesso al controsoffitto per il montaggio del motore e per la programmazione.

## E. FISSAGGIO A SOSPESO

### Tirante SG 6105

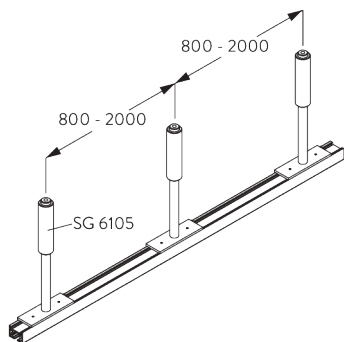

Il peso della tenda si riduce del 30%.

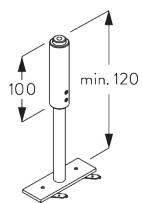

**SG 6105**

Tirante

## Tirante a V SG 6107

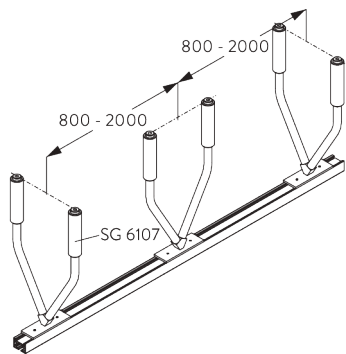

*Il peso della tenda si riduce del 30%.*

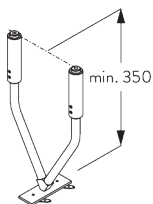

**SG 6107**

*Tirante a V*

# OPZIONI DEL SISTEMA

## A. WAVE

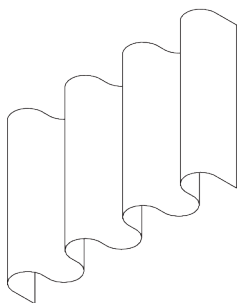

SG 6365



SG 10844

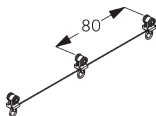

SG 10852



SG 10854



SG 10856



SG 10867



SG 10886



SG 10887

*Componenti standard:*

- SG 6365 Gancio Wave
- SG 10844 Wave fine corsa
- SG 10852 Wave 2C cavo del rullo, 80 mm
- SG 10854 Supporto carrello di sormonto Wave
- SG 10856 Carrello di estensione Wave
- SG 10867 Vite
- SG 10886 Wave estensione
- SG 10887 Wave set di bracci sovrapposti



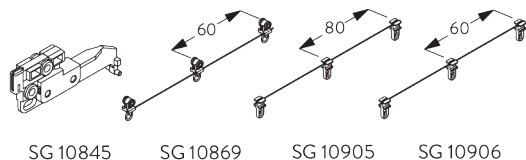

SG 10845 SG 10869 SG 10905 SG 10906

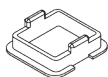

SG 10924

**Componenti Optional:**

- SG 10845 Carrello di sormonto Wave per apertura laterale 80 mm
- SG 10869 Cavo a rullo Wave 2C, 60 mm (no apertura laterale)
- SG 10905 Corda per aliante Wave, 80 mm
- SG 10906 Scivoli a pattino Wave 60 mm (no apertura laterale)
- SG 10924 Supporto scivolo Wave

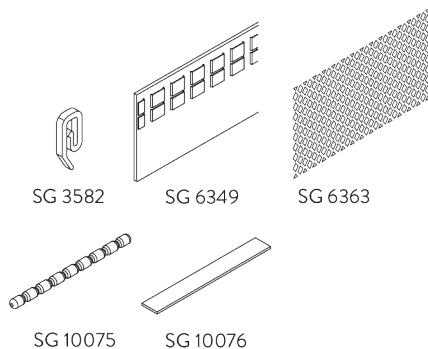

SG 3582 SG 6349 SG 6363  
SG 10075 SG 10076

**Componenti per tende:**

- SG 3582 Gancio
- SG 6349 Fettuccia tenda Wave
- SG 6363 Fettuccia metallo Wave
- SG 10075 Peso in piombo 50 gr/m
- SG 10076 Peso in tessuto

Wave: ingombro tenda impacchettata (componenti standard)

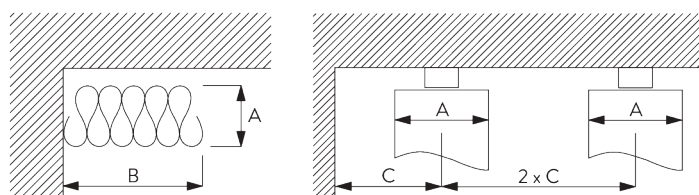

A = Ingombro in profondità  
B = Ingombro in larghezza  
C = Min. distanza

Scivoli rullo/pattino SG 10852 / 10905	Tasche tra i ganci	Ricchezza tenda approx.	Ingombro in profondità A	Ingombro in larghezza B*	Min. distanza C
80	6	~2.1	140	210 per metro di sistema	90
80	7	~2.3	160	210 per metro di sistema	100

Scivoli rullo/pattino SG 10869 / 10906	Tasche tra i ganci	Ricchezza tenda approx.	Ingombro in profondità A	Ingombro in larghezza B*	Min. distanza C
60	4	~2.1	100	260 per metro di sistema	70
60	5	~2.3	120	260 per metro di sistema	80

\*Dimensione pila B più 190 mm per ogni pila di tende!

# MOTORE & COMANDI

## A. CARATTERISTICHE DEL MOTORE

Motore	SG 9060
<b>Caratteristiche del motore</b>	
Soft start / stop	●
Touch & Go	●
Movimento a strappo	●
Ricevitore radio modulare (optional)	●
Fine corsa elettronico	●
Encoder elettronico (riavvolgimento illimitato)	●
Due posizioni intermedie programmabili	●
Collegamento in parallelo possibile senza relè addizionali	●
Motore con tecnologia Brushless	●
Sensore di posizione (anche a motore senza tensione)	●
100 - 250 V Ac e/o 24 V DC con lo stesso motore	●
Alimentazione motore con spinotto estraibile	●
Classe IP	IP 40
<b>Opzioni di controllo</b>	
In alta tensione	●
Con contatti puliti	●
Con contatti puliti e/o SG Control L (con modulo radio)	●
SG control L (con modulo radio)	●
Smart by Silent Gliss (con modulo smart)	●
Compatibile con tutti i sistemi di domotica (con le rispettive interfacce)	●

## B. SPECIFICHE DEL MOTORE

Motore	Dimensioni del motore	Voltaggio AC	Voltaggio DC	Corrente	Frequenza	Velocità del sistema / sec	Frequenza ricevitore
SG 9060	L 206 x W 60 x D 96	100 - 250 V AC	24 V DC	1.3 - 0.5 A	50 - 60 Hz	21 cm / sec	-
SG 9060 c/ SG Control L	L 226 x W 60 x D 96	100 - 250 V AC	24 V DC	1.3 - 0.5 A	50 - 60 Hz	21 cm / sec	868/915 MHz
SG 9060 c/ Smart by SG	L 226 x W 60 x D 96	100 - 250 V AC	24 V DC	1.3 - 0.5 A	50 - 60 Hz	21 cm / sec	Smart by SG

## C. DIMENSIONI DEL MOTORE / MODULI

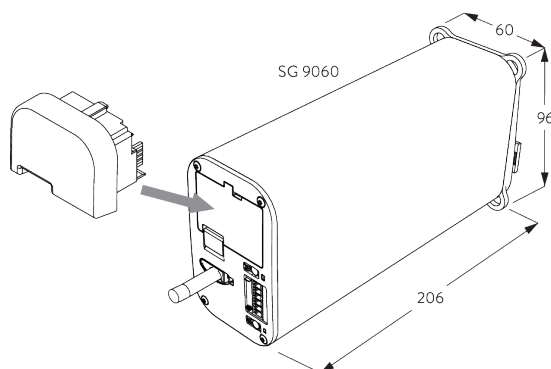

Il motore SG 9060 può essere equipaggiato con i seguente modulo:

- SG 9063 Modulo radio SG Control L

Vedere il catalogo "controlli" per dettagli.

## **D. METODI OPERATIVI**

Vedere il catalogo "sistemi di controllo" per dettagli.

**Pulsante a parete**



*Il sistema può essere controllato da un doppio pulsante a parete.*

**SG Control L**



*Varie tipologie di trasmettitori radio disponibili.*



*Applicazione Silent Gliss Move.*

**Smart by Silent Gliss**



*Sistema di comunicazione bidirezionale dal design aperto che consente di integrare perfettamente i prodotti con la maggior parte dei principali sistemi di gestione degli edifici. È necessario il modulo smart SG 11270.*

## **E. SCHEMI DI COLLEGAMENTO**



*Disponibili sul sito web Silent Gliss.*

# COMPONENTI

## A. COMPONENTI STANDARD

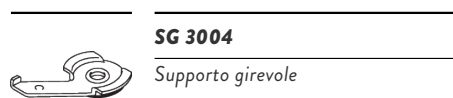

**SG 3004**

Supporto girevole

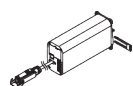

**SG 9060**

Motore 100-250V AC & 24V CC

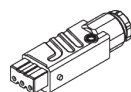

**SG 9917**

Preso Hirschmann STAK 3 N

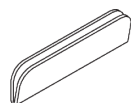

**SG 10725**

Distanziatore per programmazione finecorsa

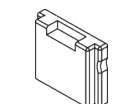

**SG 10815**

Cover guida

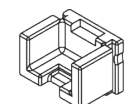

**SG 10816**

Cover motore

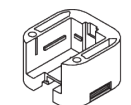

**SG 10817**

Supporto motore

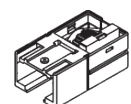

**SG 10819**

Guida di ritorno

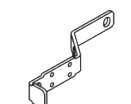

**SG 10821**

Carrello di sormonto piegato

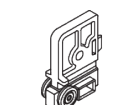

**SG 10822**

Scivolo pilota

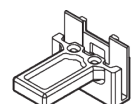

**SG 10823**

Connettore banda di trascinamento

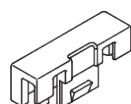

**SG 10824**

Connettore banda di trascinamento

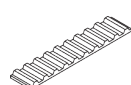

**SG 10825**

Banda di trascinamento

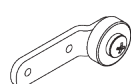

**SG 10826**

Supporto carrello di sormonto

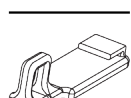

**SG 10836**

Occhiolo guida

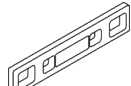

**SG 10837**

Scivolo pilota

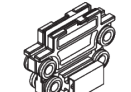

**SG 10838**

Scivolo pilota apertura centrale



**SG 10840**

Scivolo a rullo 2C con occhiolo in acciaio

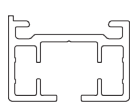

**SG 10850**

Profilo

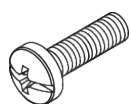

**SG 10923**

Vite a testa cilindrica Freedriv M4x12

## B. COMPONENTI OPTIONAL

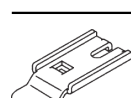

**SG 3041**

Supporto



**SG 3582**

Gancio a G

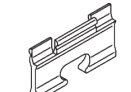

**SG 5118**

Spessore per incasso

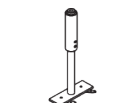

**SG 6105**

Tirante



**SG 6107**

Tirante a V

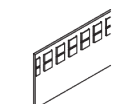

**SG 6349**

Fettuccia wave



**SG 6363**

Fettuccia termosaldabile

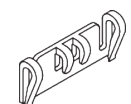

**SG 6365**

Gancio wave

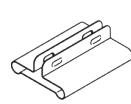

**SG 7002**

Accessorio di protezione profilo

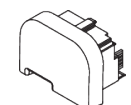

**SG 9063**

Modulo ricevitore radio

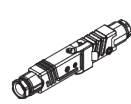

**SG 9916**

Set spine Hirschmann



**SG 10074**

Vite a testa svasata M4x8













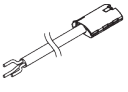
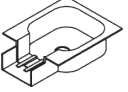
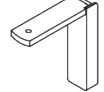
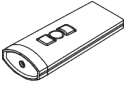
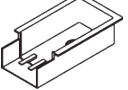
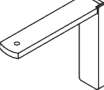

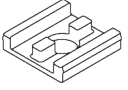
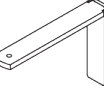
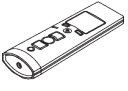
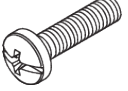
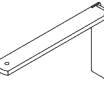
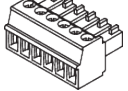

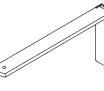
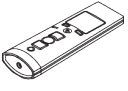
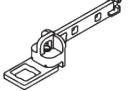
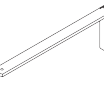
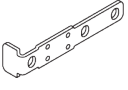
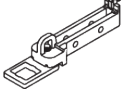
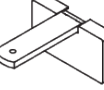
**SG 10075**

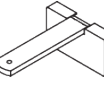
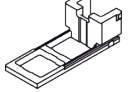
Piombo 50 g/m

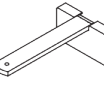
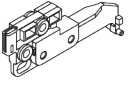
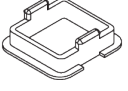
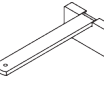

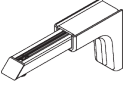
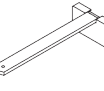
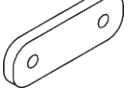
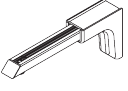
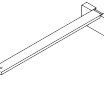
**SG 10076**

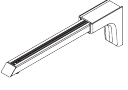
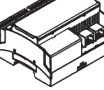
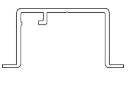
Piatina peso

	<b>SG 10293</b> Cavo di alimentazione 230V AC, 2/3/5/10 m		<b>SG 10863</b> Mascherina per incasso		<b>SG 11200</b> Smart Fix 60 mm
	<b>SG 10300</b> Trasmittitore radio 1 canale		<b>SG 10864</b> Mascherina per incasso		<b>SG 11201</b> Smart Fix 80 mm
	<b>SG 10302</b> Trasmittitore radio 5+1 canali		<b>SG 10865</b> Supporto per fissaggio diretto		<b>SG 11202</b> Smart Fix 100 mm
	<b>SG 10303</b> Trasmittitore radio 10+2+1 canali		<b>SG 10867</b> Vite a testa cilindrica Freedriv M4x16		<b>SG 11203</b> Smart Fix 120 mm
	<b>SG 10714</b> Spina 6-pin, MC 1.5/6-ST-3.81		<b>SG 10869</b> Scivolo a rullo wave 2C passo 60 mm		<b>SG 11204</b> Smart Fix 150 mm
	<b>SG 10804</b> Trasmittitore radio 15+5+1 canali		<b>SG 10886</b> Carrello wave apertura centrale		<b>SG 11205</b> Smart Fix 200 mm
	<b>SG 10820</b> Carrello di sormonto diritto		<b>SG 10887</b> Carrello wave apertura centrale		<b>SG 11210</b> Smart Fix squadrato 60 mm
	<b>SG 10831</b> Congiunzione		<b>SG 10905</b> Scivolo a pattino wave passo 80 mm		<b>SG 11211</b> Smart Fix squadrato 80 mm
	<b>SG 10844</b> Fermo scivolo wave		<b>SG 10906</b> Scivolo a pattino wave passo 60 mm		<b>SG 11212</b> Smart Fix squadrato 100 mm
	<b>SG 10845</b> Carrello di sormonto wave apertura laterale 80 mm		<b>SG 10924</b> Supporto scivolo wave		<b>SG 11213</b> Smart Fix squadrato 120 mm
	<b>SG 10852</b> Scivolo a rullo wave 2C passo 80 mm		<b>SG 11154</b> Smart fix universale 120 mm		<b>SG 11214</b> Smart Fix squadrato 150 mm
	<b>SG 10854</b> Supporto carrello di sormonto wave		<b>SG 11155</b> Smart fix universale 150 mm		<b>SG 11215</b> Smart Fix squadrato 200 mm
	<b>SG 10856</b> Estensione Wave		<b>SG 11156</b> Smart fix universale 200 mm		<b>SG 11260</b> Gateway Cedia
	<b>SG 10862</b> Profilo per incasso		<b>SG 11158</b> Vite a testa svasata M4x12		<b>SG 11261</b> Gateway KNX

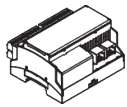
**SG 11262**

Unità di espansione

---

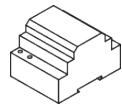
**SG 11264**

Alimentatore 24V CC, 3.8 ampere per barra DIN

---

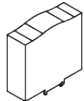
**SG 11265**

Alimentatore 24V CC, 5 ampere per barra DIN

---

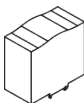
**SG 11266**

Alimentatore 24V CC, 10 ampere per barra DIN

---

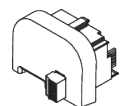
**SG 11270**

Modulo Smart

---

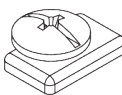
**SG 11295**

Fermo con vite

---

**SG 11325**

Spina Smart 6-pin, MC 1.5/6-ST-3.81

---

**SG 11480**

Trasmettitore radio da parete 1 canale

---

**SG 11490**

Trasmettitore radio da parete 5 + 1 canali

---



