

SG 6243

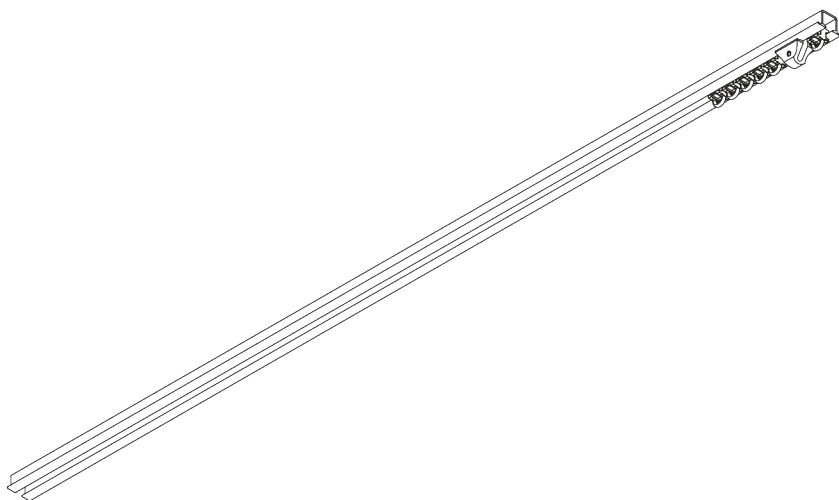

INFORMAZIONI SUL PRODOTTO

- **Movimentazione:** strappo
- **Range:** S - M
- **Fissaggio:** incasso
- **Finiture:** verniciato bianco RAL 9016 e anodizzato argento, altri RAL su richiesta
- **Tessuti:** Silent Gliss Collection

Caratteristiche:

- Tecnologia a 2 componenti (2C)
- Wave (2C)
- Curvabile in piano
- Profilo pre-forato

SPECIFICHE DEL SISTEMA

A. PROFILO

Profilo e informazioni di curvatura

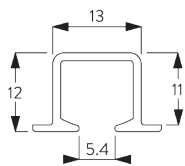

SG 6243p

Profilo

Raggio:
✓ 20 cm, >25 cm

B. MISURE

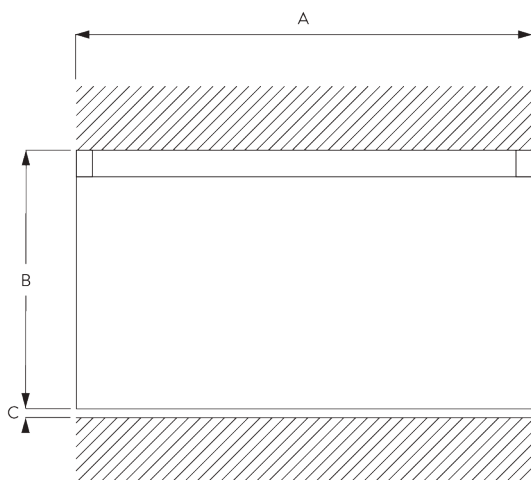

A: Larghezza sistema

B: Altezza sistema

C: Distanza del tessuto dal pavimento

INSTALLAZIONE

A. INFORMAZIONI DI FISSAGGIO

Per maggiori dettagli sul fissaggio, visita il sito web [Silent Gliss](#).

Punti di fissaggio

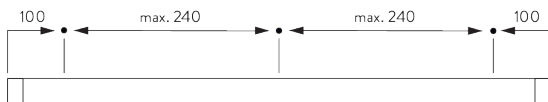

B. FISSAGGIO A INCASSO

Direttamente nel legno

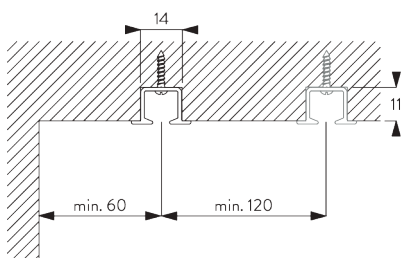

Canale di incasso: 11 x 14 mm

OPZIONI DEL SISTEMA

A. WAVE

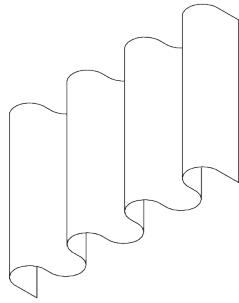

SG 11295

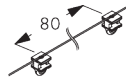

SG 11302



SG 2255



SG 2256

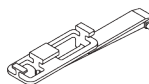

SG 6364



SG 6365

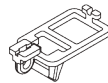

SG 6366

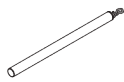

SG 10430-34

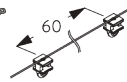

SG 11303

Componenti standard:

- SG 11295 Vite di arresto
- SG 11302 Scivolo a pattino Wave 2C 80 mm

Componenti opzionali (raggio min: >25 cm):

- SG 2255 Freno
- SG 2256 Freno
- SG 6364 Estensione Wave
- SG 6365 Gancio Wave
- SG 6366 Scivolo Wave per asta
- SG 10430-34 Asta
- SG 11303 Scivolo a pattino Wave 2C 60 mm



SG 3582

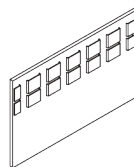

SG 6349

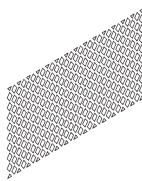

SG 6363

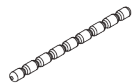

SG 10075



SG 10076

Componenti per tende:

- SG 3582 Gancio
- SG 6349 Fettuccia tenda Wave
- SG 6363 Fettuccia metallo Wave
- SG 10075 Peso in piombo 50 gr/m
- SG 10076 Peso in tessuto

Wave: ingombro tenda impacchettata (componenti standard)

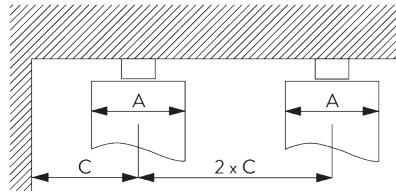
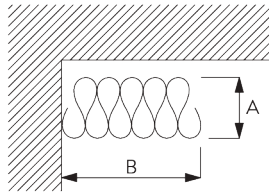

A = Ingombro in profondità
 B = Ingombro in larghezza
 C = Min. distanza

Scivoli rullo/pattino SG 11302	Tasche tra i ganci	Ricchezza tenda approx.	Ingombro in profondità A	Ingombro in larghezza B*	Min. distanza C
80	6	~2.1	140	180 per metro di sistema	90
80	7	~2.3	160	180 per metro di sistema	100

Scivoli rullo/pattino SG 11303	Tasche tra i ganci	Ricchezza tenda approx.	Ingombro in profondità A	Ingombro in larghezza B*	Min. distanza C
60	4	~2.1	100	230 per metro di sistema	70
60	5	~2.3	120	230 per metro di sistema	80

*La dimensione della pila B quando si utilizza il braccio di prolunga opzionale SG 6364 aumenta di 150 mm per pila di tende!

COMPONENTI

A. COMPONENTI STANDARD



SG 6065
Arresto con occhio

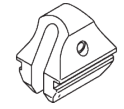

SG 6086
Molla di chiusura

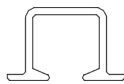

SG 6243p
Profilo



SG 10717
Vite a testa svasata 2,2x19

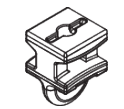

SG 11300
Scivolo 2C

B. COMPONENTI OPTIONAL

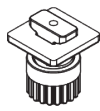

SG 2255
Freno

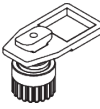

SG 2256
Freno



SG 3012
Gancio



SG 3020
Gancetto in ottone nichelato

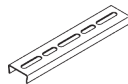

SG 3067
Congiunzione



SG 3581
Gancio



SG 3582
Gancio a G

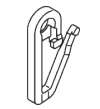

SG 3598
Occhio



SG 6053
Fermo a molla



SG 6057
Scivolo



SG 6064
Arresto senza occhio

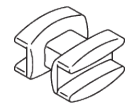

SG 6082
Scivolo da cucire



SG 6094
Scivolo a rullo con gancio in acciaio



SG 6098
Scivolo a rullo con occhio in acciaio



SG 6240
Scivolo a rullo



SG 6283
Scivolo a rullo



SG 6349
Fettuccia wave

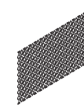

SG 6363
Fettuccia termosaldabile



SG 6364
Carrello wave

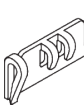

SG 6365
Gancio wave

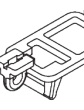

SG 6366
Scivolo pilota wave con aggancio

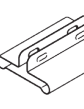

SG 7002
Accessorio di protezione profilo

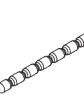

SG 10075
Piombo 50 g/m

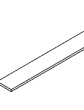

SG 10076
Piattina peso

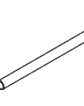

SG 10430
Asta in alluminio 50 cm

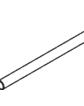

SG 10431
Asta in alluminio 75 cm

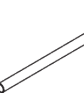

SG 10432
Asta in alluminio 100 cm

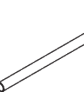

SG 10433
Asta in alluminio 125 cm

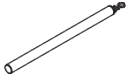

SG 10434

Asta in alluminio 150 cm

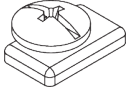

SG 11295

Fermo con vite



SG 11301

Scivolo 2C in matarozza

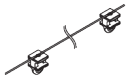

SG 11302

Scivoli a pattino 2C wave 80 mm

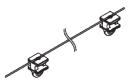

SG 11303

Scivoli a pattino 2C wave 60 mm

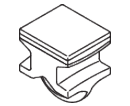

SG 11305

Scivolo 2C da cucire
