

SG 6475

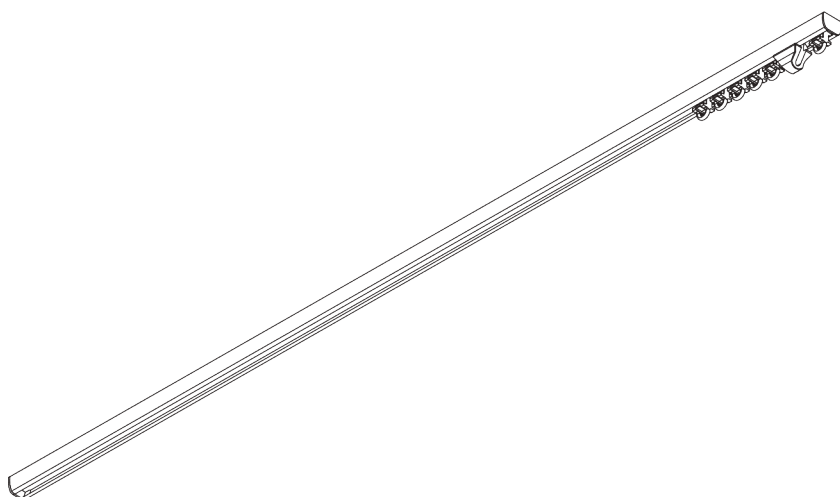

INFORMAZIONI SUL PRODOTTO

- **Movimentazione:** strappo
- **Range:** S
- **Fissaggio:** soffitto
- **Finiture:** verniciato bianco RAL 9016 o argento anodizzato, altri RAL su richiesta
- **Tessuti:** Silent Gliss Collection

Caratteristiche

- Tecnologia a 2 componenti (2C)
- Wave (2C)
- Curvabile in piano

SPECIFICHE DEL SISTEMA

A. PROFILO

Profilo e informazioni di curvatura

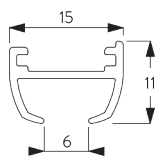

SG 6475p

Profilo

Raggio:
✓ 8 cm, 12 cm, 16 cm,
>25 cm

B. MISURE

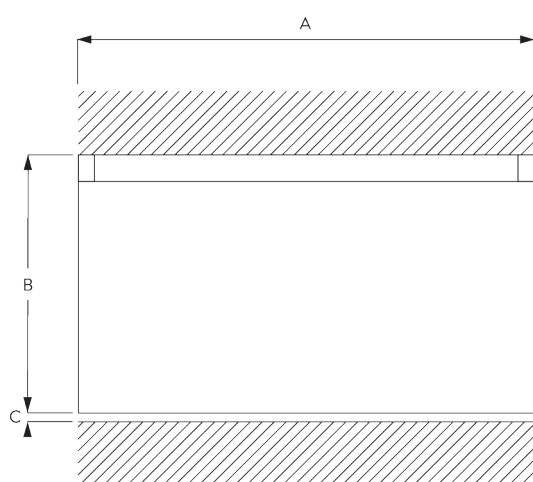

A: Larghezza sistema

B: Altezza sistema

C: Distanza del tessuto dal pavimento

INSTALLAZIONE

A. INFORMAZIONI DI FISSAGGIO

Per maggiori dettagli sul fissaggio, visita il sito web [Silent Gliss](#).

Punti di fissaggio

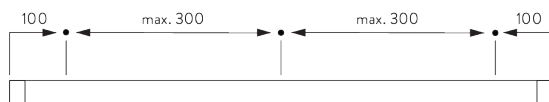

B. FISSAGGIO A SOFFITTO

Supporto girevole SG 3060

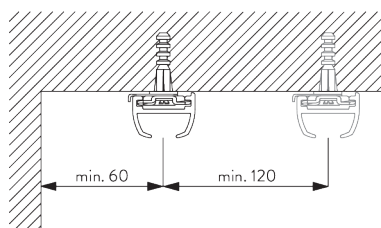

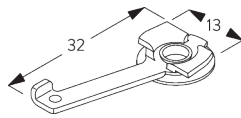

SG 3060

Supporto girevole

OPZIONI DEL SISTEMA

A. WAVE

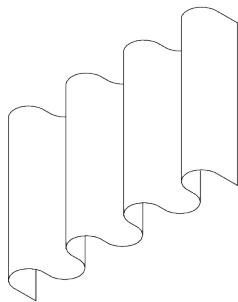

SG 11295

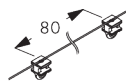

SG 11302



SG 2255

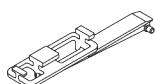

SG 6364



SG 6365

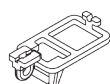

SG 6366

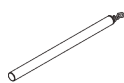

SG 10430-34

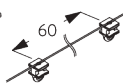

SG 11303

Componenti standard:

- SG 11295 Vite di arresto
- SG 11302 Scivolo a pattino Wave 2C 80 mm

Componenti opzionali (raggio min: >25 cm):

- SG 2255 Freno
- SG 6364 Estensione Wave
- SG 6365 Gancio Wave
- SG 6366 Scivolo Wave per asta
- SG 10430-34 Asta
- SG 11303 Scivolo a pattino Wave 2C 60 mm



SG 3582

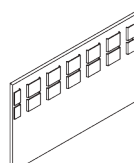

SG 6349

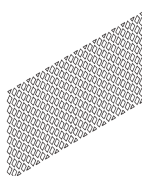

SG 6363

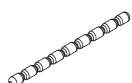

SG 10075



SG 10076

Componenti per tende:

- SG 3582 Gancio
- SG 6349 Fettuccia tenda Wave
- SG 6363 Fettuccia metallo Wave
- SG 10075 Peso in piombo 50 gr/m
- SG 10076 Peso in tessuto

Wave: ingombro tenda impacchettata (componenti standard)

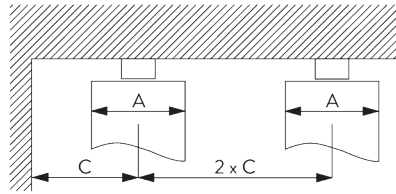
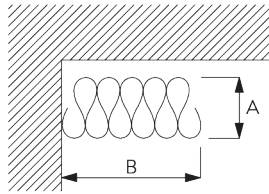

A = Ingombro in profondità
B = Ingombro in larghezza
C = Min. distanza

Scivoli rullo/pattino SG 11302	Tasche tra i ganci	Ricchezza tenda approx.	Ingombro in profondità A	Ingombro in larghezza B*	Min. distanza C
80	6	~2.1	140	180 per metro di sistema	90
80	7	~2.3	160	180 per metro di sistema	100

Scivoli rullo/pattino SG 11303	Tasche tra i ganci	Ricchezza tenda approx.	Ingombro in profondità A	Ingombro in larghezza B*	Min. distanza C
60	4	~2.1	100	230 per metro di sistema	70
60	5	~2.3	120	230 per metro di sistema	80

*La dimensione della pila B quando si utilizza il braccio di prolunga opzionale SG 6364 aumenta di 150 mm per pila di tende!

NOTE GENERALI

Dimensioni

- Le misure sono in mm, tranne dove indicate.
- Max. Kg è relativo al peso tessuto (accessori inclusi).
- Lo spazio di impacchettamento dipende dal tipo di confezione della tenda e dallo spessore del tessuto.
- Distanza tra gli scivoli a pattino max. 80 mm / tra gli scivoli a rullo max. 100 mm.
- Distanza del tessuto dal pavimento consigliata: 20 mm.
- Per determinare l'altezza del sistema (B), considerare l'altezza minore rilevata.

Installazione







- Installazione solo a cura di personale qualificato.
- Il numero dei punti di fissaggio e il loro posizionamento sono determinati soprattutto dalla superficie di installazione, dalla confezione del tessuto, e da eventuali ostacoli nella corsa.
- Il personale qualificato deve utilizzare viti e sistemi di fissaggio adeguati ad ogni situazione.
- Lo scalino superiore del profilo va sempre rivolto verso l'interno stanza.

Child Safety

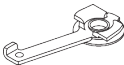
- Tutti i sistemi Silent Gliss rispettano la norma EN 13120.
- Tutte le parti utilizzate rispettano la norma EN 13120.

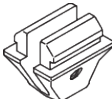

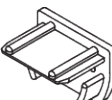
COMPONENTI

A. COMPONENTI STANDARD

	SG 3060 Supporto girevole
	SG 6065 Arresto con occhio
	SG 6245 Molla di chiusura
	SG 6475p Profilo
	SG 6476 Tappo profilo
	SG 11300 Scivolo 2C

B. COMPONENTI OPTIONAL

	SG 2255 Freno
	SG 3062 Congiunzione
	SG 3582 Gancio a G
	SG 6349 Fettuccia wave
	SG 6363 Fettuccia termosaldabile
	SG 6364 Carrello wave
	SG 6365 Gancio wave
	SG 6366 Scivolo pilota wave con aggancio
	SG 10075 Piombo 50 g/m
	SG 10076 Piattina peso
	SG 10430 Asta in alluminio 50 cm
	SG 10431 Asta in alluminio 75 cm
	SG 10432 Asta in alluminio 100 cm
	SG 10433 Asta in alluminio 125 cm

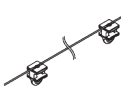
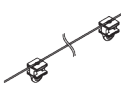
	SG 10434 Asta in alluminio 150 cm
	SG 11295 Fermo con vite
	SG 11301 Scivolo 2C in matarozza
	SG 11302 Scivoli a pattino 2C wave 80 mm
	SG 11303 Scivoli a pattino 2C wave 60 mm

