

SG 6970

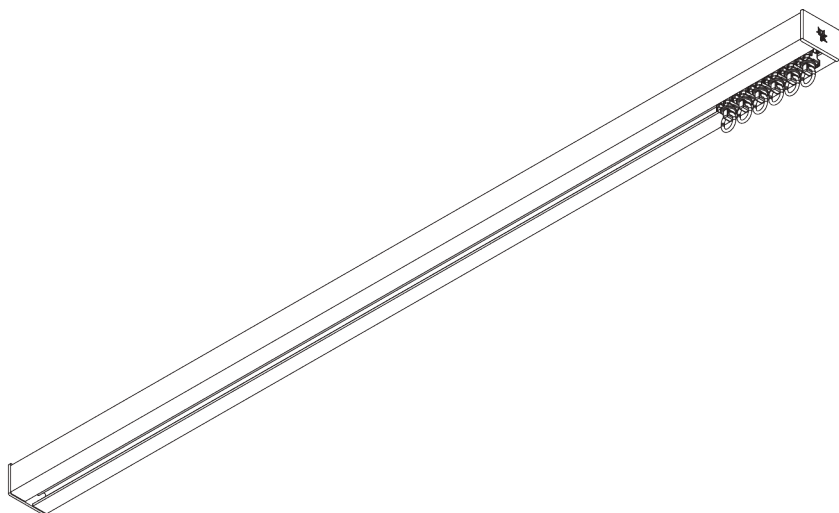

INFORMAZIONI SUL PRODOTTO

- **Movimentazione:** strappo
- **Range:** M - L
- **Fissaggio:** soffitto, parete, incasso
- **Finiture:** verniciato bianco RAL 9016, verniciato nero RAL 9005 o argento anodizzato, altri RAL su richiesta (profilo incasso solo in bianco RAL 9016, verniciato nero RAL 9005 o colore speciale)
- **Tessuti:** Silent Gliss Collection

Caratteristiche

- Scivolo con tecnologia a 2 componenti (2C)
- Wave (2C)
- Curvabile in piano
- Profilo a incasso curvabile in piano

SPECIFICHE DEL SISTEMA

A. PROFILO

Profilo e informazioni di curvatura

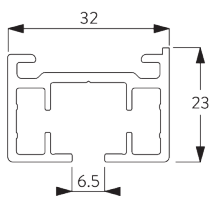

SG 10850

Profilo

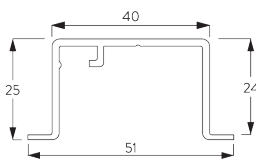

SG 10862

Profilo per incasso



B. MISURE

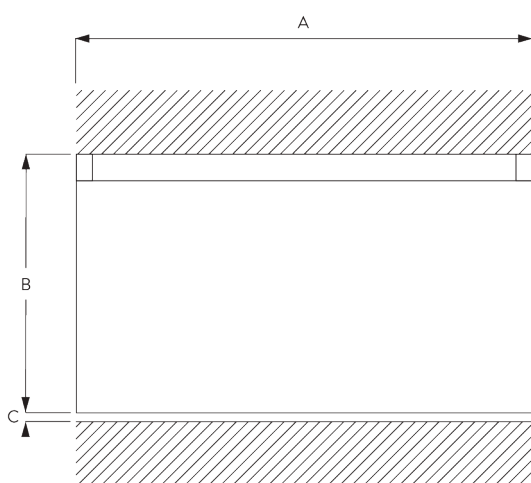

A: Larghezza sistema

B: Altezza sistema

C: Distanza del tessuto dal pavimento

INSTALLAZIONE

A. INFORMAZIONI DI FISSAGGIO

Per maggiori dettagli sul fissaggio, visita il sito web Silent Gliss.

Punti di fissaggio

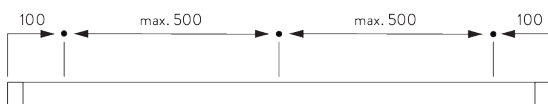

B. FISSAGGIO A SOFFITTO

Supporto girevole SG 3004

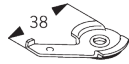
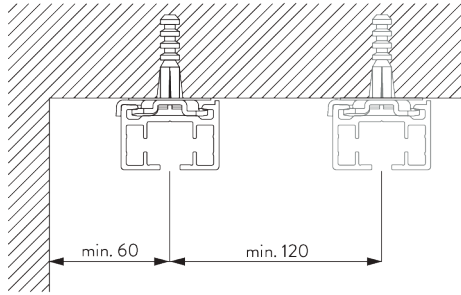

SG 3004

Supporto girevole

Fissaggio frontale

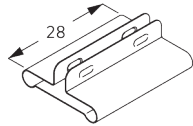
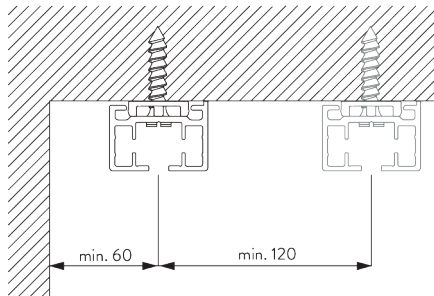

SG 7002

Accessorio di protezione profilo

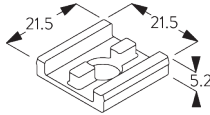

SG 10865

Supporto per fissaggio diretto

Supporto SG 3041

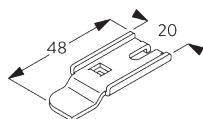
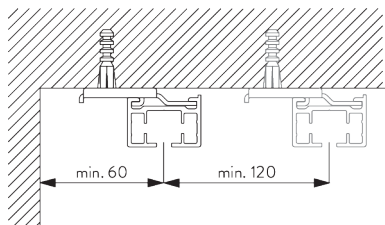

SG 3041

Supporto

C. FISSAGGIO A PARETE

Smart Fix

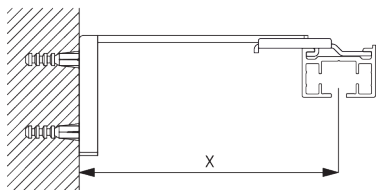

Smart Fix SG 11200 - SG 11205 e supporto SG 3041:
Necessaria vite SG 10492 (M4x8).

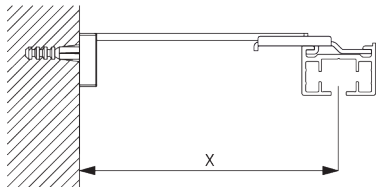

Smart Fix squadrato SG 11210 - SG 11215 e supporto SG 3041:
Necessaria vite SG 10492 (M4x8).

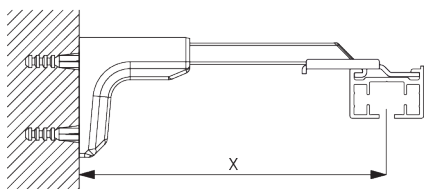

Smart Fix universale SG 11154 - SG 11156 e supporto SG 3041:
Necessaria vite SG 10407 (M4x10).

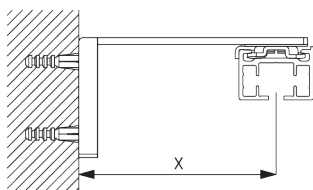

Smart Fix SG 11201 - SG 11205 e supporto girevole SG 3004:
Necessaria vite SG 10074 (M4x8).

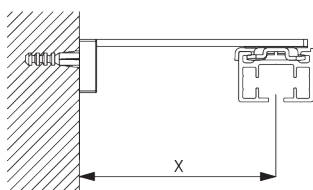

Smart Fix squadrato SG 11211 - SG 11215 e supporto girevole SG 3004:
Necessaria vite SG 10074 (M4x8).

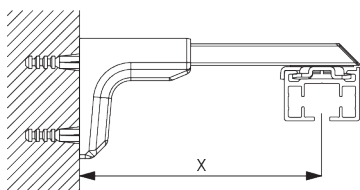

Smart Fix universale SG 11154 - SG 11156 e supporto SG 3004:
Necessaria vite SG 11158 (M4x12).

Smart Fix	X mm (SG 3041)	X mm (SG 3004)
SG 11200 / SG 11210	83	
SG 11201 / SG 11211	103	72
SG 11202 / SG 11212	123	92
SG 11203 / SG 11213	143	112
SG 11204 / SG 11214	173	142
SG 11205 / SG 11215	223	192
SG 11154	128-156	102-130
SG 11155	158-186	132-160
SG 11156	208-236	182-210

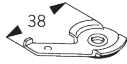

SG 3004
Supporto girevole

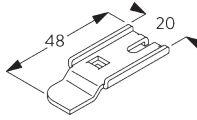

SG 3041
Supporto



SG 10074
Vite a testa svasata M4x8



SG 10407
Vite a testa cilindrica M4x10



SG 10492
Vite a testa cilindrica M4x8



SG 11158
Vite a testa svasata M4x12

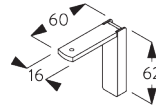

SG 11200
Smart Fix 60 mm

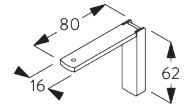

SG 11201
Smart Fix 80 mm

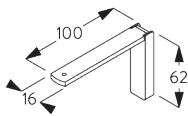

SG 11202
Smart Fix 100 mm

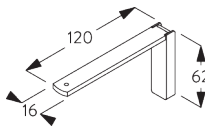

SG 11203
Smart Fix 120 mm

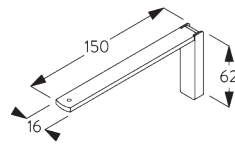

SG 11204
Smart Fix 150 mm

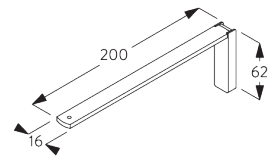

SG 11205
Smart Fix 200 mm

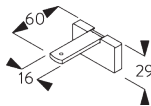

SG 11210
Smart Fix squadrato 60 mm

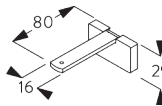

SG 11211
Smart Fix squadrato 80 mm

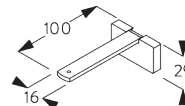

SG 11212
Smart Fix squadrato 100 mm

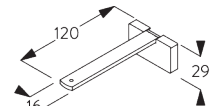

SG 11213
Smart Fix squadrato 120 mm

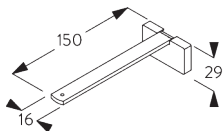

SG 11214
Smart Fix squadrato 150 mm

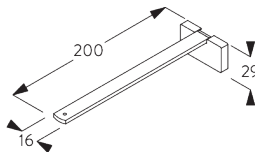

SG 11215
Smart Fix squadrato 200 mm

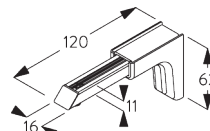

SG 11154
Smart fix universale 120 mm

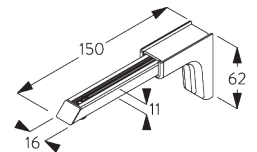

SG 11155
Smart fix universale 150 mm

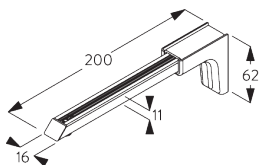

SG 11156
Smart fix universale 200 mm

D. FISSAGGIO A INCASSO

Profilo a incasso SG 10862

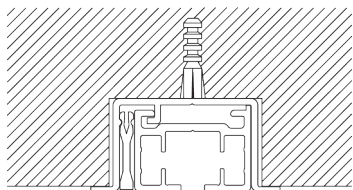

Uno spessore per profilo a incasso SG 5118 per ogni punto di fissaggio.

Per maggiori informazioni a riguardo del fissaggio a incasso, visitare il sito web Silent Gliss.

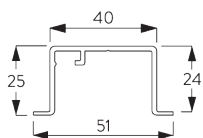

SG 10862

Profilo per incasso

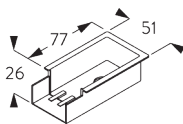

SG 10864

Mascherina per incasso

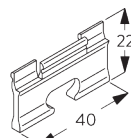

SG 5118

Spessore per incasso

E. FISSAGGIO A SOSPESO

Tirante SG 6105

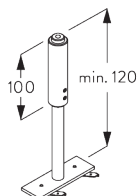
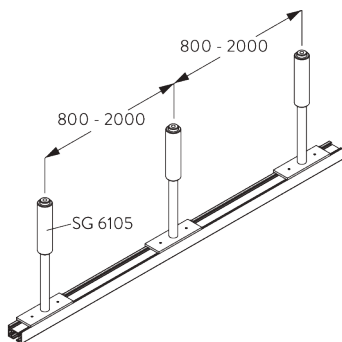

SG 6105

Tirante

Tirante a V SG 6107

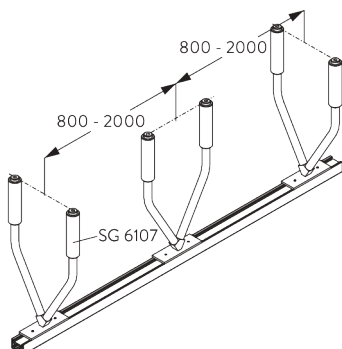

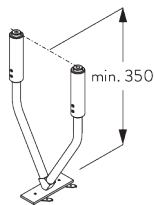

SG 6107

Tirante a V

OPZIONI DEL SISTEMA

A. WAVE

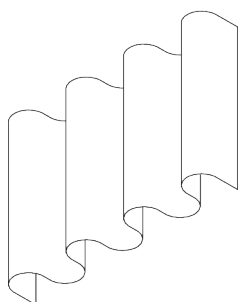

SG 11295

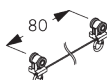

SG 10852

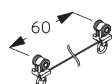

SG 10869

Componenti standard:

- SG 11295 Vite di arresto
- SG 10852 Scivolo a pattino Wave 2C 80 mm

Componenti opzionali:

- SG 10869 Scivolo a pattino Wave 2C 60 mm



SG 3582

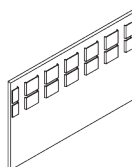

SG 6349

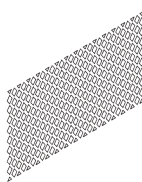

SG 6363

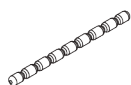

SG 10075



SG 10076

Componenti per tende:

- SG 3582 Gancio
- SG 6349 Fettuccia tenda Wave
- SG 6363 Fettuccia termosaldabile Wave
- SG 10075 Peso in piombo 50 gr/m
- SG 10076 Peso in tessuto

Wave: ingombro tenda impacchettata (componenti standard)

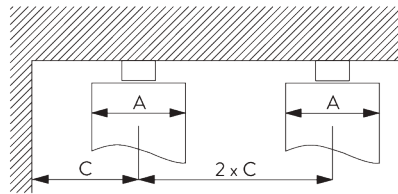
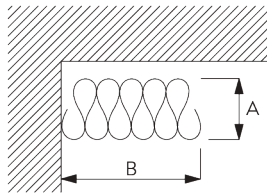



A = Ingombro in profondità
 B = Ingombro in larghezza
 C = Min. distanza

Scivoli rullo/pattino SG 10852	Tasche tra i ganci	Ricchezza tenda approx.	Ingombro in profondità A	Ingombro in larghezza B	Min. distanza C
80	6	~2.1	140	210 per metro di sistema	90
80	7	~2.3	160	210 per metro di sistema	100







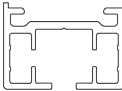
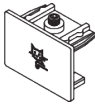
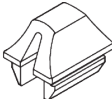



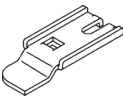
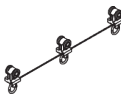

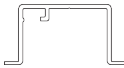
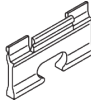
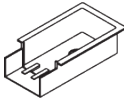

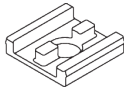
Scivoli rullo/pattino SG 10869	Tasche tra i ganci	Ricchezza tenda approx.	Ingombro in profondità A	Ingombro in larghezza B	Min. distanza C
60	4	~2.1	100	260 per metro di sistema	70
60	5	~2.3	120	260 per metro di sistema	80

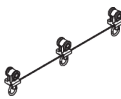
COMPONENTI

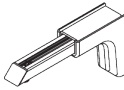
A. COMPONENTI STANDARD

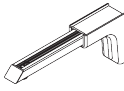
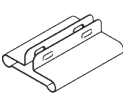
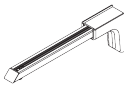
	SG 3004 Supporto girevole
	SG 10840 Scivolo a rullo 2C con occhio in acciaio
	SG 10850 Profilo
	SG 11235 Tappo profilo
	SG 11465 Molla di chiusura

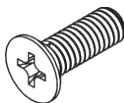
B. COMPONENTI OPTIONAL

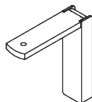
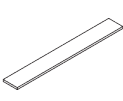
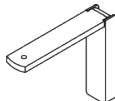
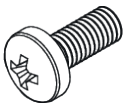
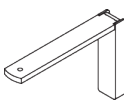
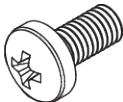
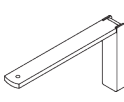
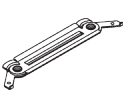
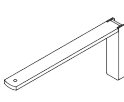
	SG 3041 Supporto		SG 10852 Scivolo a rullo wave 2C passo 80 mm
	SG 3582 Gancio a G		SG 10862 Profilo per incasso
	SG 5118 Spessore per incasso		SG 10864 Mascherina per incasso
	SG 6105 Tirante		SG 10865 Supporto per fissaggio diretto
	SG 6107 Tirante a V		SG 10869 Scivolo a rullo wave 2C passo 60 mm
	SG 6349 Fettuccia wave		SG 11154 Smart fix universale 120 mm
	SG 6363 Fettuccia termosaldabile		SG 11155 Smart fix universale 150 mm
	SG 7002 Accessorio di protezione profilo		SG 11156 Smart fix universale 200 mm
	SG 10074 Vite a testa svasata M4x8		SG 11158 Vite a testa svasata M4x12
	SG 10075 Piombo 50 g/m		SG 11200 Smart Fix 60 mm
	SG 10076 Piattina peso		SG 11201 Smart Fix 80 mm
	SG 10407 Vite a testa cilindrica M4x10		SG 11202 Smart Fix 100 mm
	SG 10492 Vite a testa cilindrica M4x8		SG 11203 Smart Fix 120 mm
	SG 10831 Congiunzione		SG 11204 Smart Fix 150 mm



SG 11205

Smart Fix 200 mm

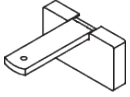

SG 11210

Smart Fix squadrato 60 mm

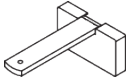

SG 11211

Smart Fix squadrato 80 mm

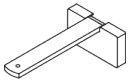

SG 11212

Smart Fix squadrato 100 mm

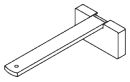

SG 11213

Smart Fix squadrato 120 mm

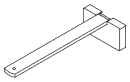

SG 11214

Smart Fix squadrato 150 mm

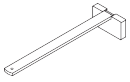

SG 11215

Smart Fix squadrato 200 mm

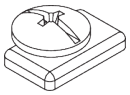

SG 11295

Fermo con vite
