

SG 2700

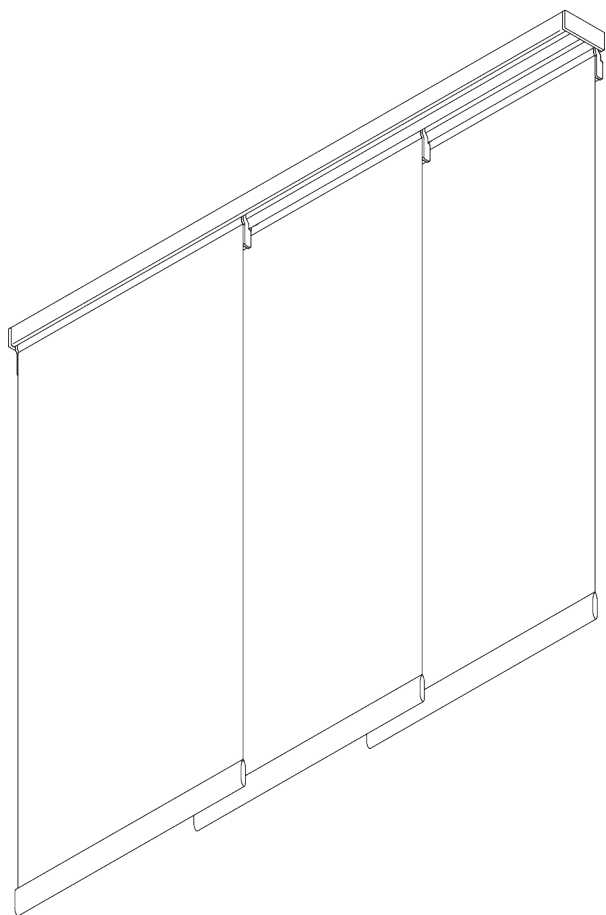

INFORMAZIONI SUL PRODOTTO

- **Movimentazione:** manuale
- **Range:** S - L
- **Fissaggio:** soffitto, parete, incasso
- **Finiture:** verniciato bianco RAL 9016 o argento anodizzato, altri RAL su richiesta
- **Tessuti:** Silent Gliss Collection

Caratteristiche

- Scivolo a rullo con tecnologia a 2 componenti (2C)
- Scorrimento fluido e silenzioso
- Slitte in alluminio
- Pannelli liberi oppure collegati

SPECIFICHE DEL SISTEMA

A. DIMENSIONI DEL SISTEMA



Pannelli liberi: illimitata
Pannelli collegati: 6 m

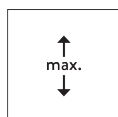

4 m



Max. 2 kg per m

B. PROFILO

Informazioni sul profilo

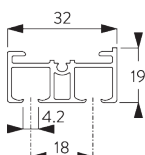

SG 10122

Profilo a 2 vie

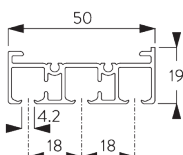

SG 10123

Profilo a 3 vie

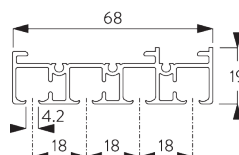

SG 10124

Profilo a 4 vie

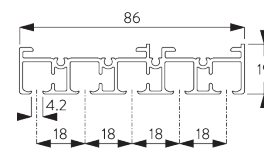

SG 10125

Profilo a 5 vie

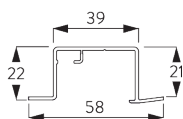

SG 10172

Profilo per incasso 10122

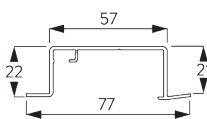

SG 10173

Profilo per incasso 10123

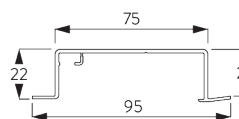

SG 10174

Profilo per incasso 10124

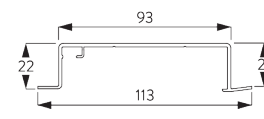

SG 10175

Profilo per incasso 10125

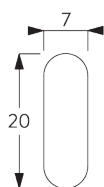

SG 2004

Profilo balza

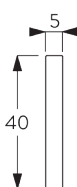

SG 2005

Profilo balza

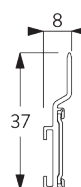

SG 10230

Carrello in alluminio

C. MISURE

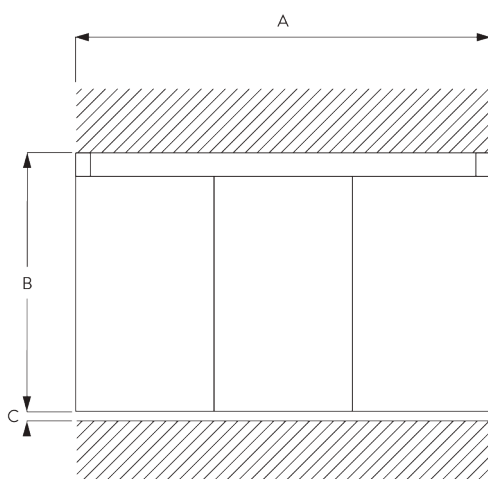

A: Larghezza sistema

B: Altezza sistema

C: Distanza del tessuto dal pavimento

Dimensioni dei pannelli

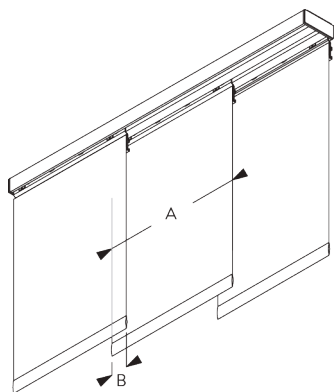

Pannelli liberi:

A: Larghezza pannello consigliata: 500-1200

Pannelli collegati:

A: Larghezza pannelli consigliata: 500-1200

B: Sormonto: min. 50

INSTALLAZIONE

A. INFORMAZIONI DI FISSAGGIO

Per maggiori dettagli sul fissaggio, visita il sito web [Silent Gliss](http://SilentGliss.com).

Punti di fissaggio

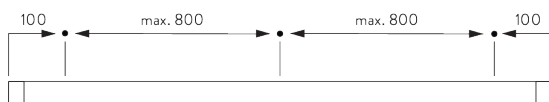

B. FISSAGGIO A SOFFITTO

Supporto girevole SG 3003 / SG 3004

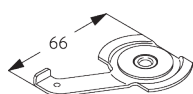
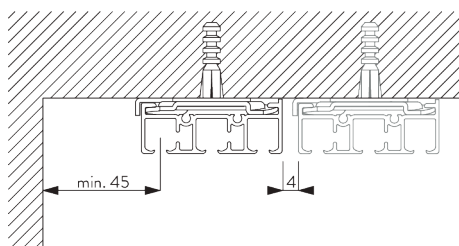

SG 3003

Supporto girevole

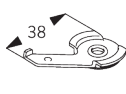

SG 3004

Supporto girevole

Supporto girevole	SG 10122	SG 10123	SG 10124	SG 10125
SG 3004	X			
SG 3003		X	X	X

Supporto SG 10136 / SG 10137

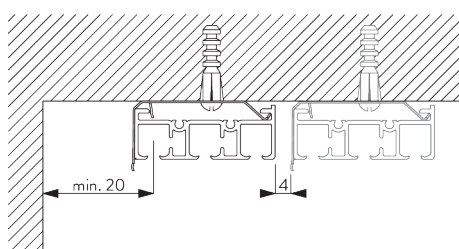

Supporto	SG 10122	SG 10123	SG 10124
SG 10136	X		
SG 10137		X	X

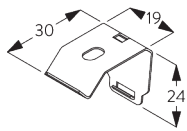

SG 10136

Supporto a scatto

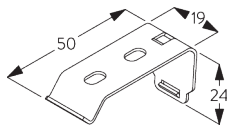

SG 10137

Supporto a scatto

C. FISSAGGIO A PARETE

Smart Fix

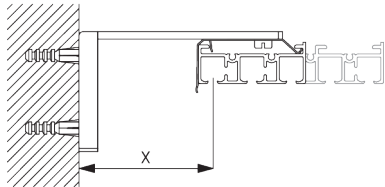

Smart Fix SG 11200 - SG 11204:

Supporto SG 10136 per profilo a 2 vie.
Supporto SG 10137 per profili a più di 2 vie.
Vite SG 10395 (M4x6) necessaria.

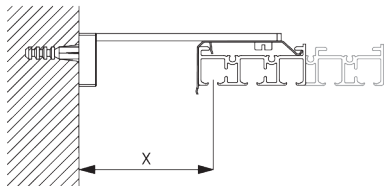

Smart Fix squadrato SG 11210 - SG 11214:

Supporto SG 10136 per profilo a 2 vie.
Supporto SG 10137 per profili a più di 2 vie.
Vite SG 10395 (M4x6) necessaria.

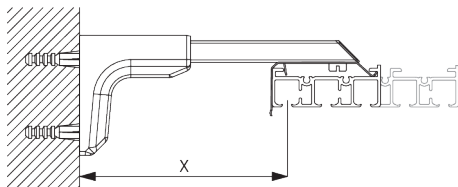

Smart Fix universale SG 11154 - SG 11156:

Supporto SG 10136 per profilo a 2 vie.
Supporto SG 10137 per profili a più di 2 vie.
Vite SG 10492 (M4x8) necessaria.

Smart Fix	X mm (SG 10122)	X mm (SG 10123)	X mm (SG 10124)	X mm (SG 10125)
SG 11200 / SG 11210	43	24	24	24
SG 11201 / SG 11211	63	44	44	44
SG 11202 / SG 11212	83	64	64	64
SG 11203 / SG 11213	103	84	84	84
SG 11204 / SG 11214	133	114	114	114
SG 11154	93-121	74-102	74-102	74-102
SG 11155	123-151	104-132	104-132	104-132
SG 11156	172-201	154-182	154-182	154-182

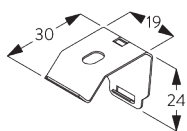

SG 10136

Supporto a scatto

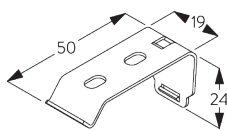

SG 10137

Supporto a scatto



SG 10395

Vite a testa cilindrica M4x6



SG 10492

Vite a testa cilindrica M4x8

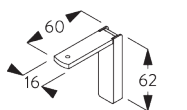

SG 11200

Smart Fix 60 mm

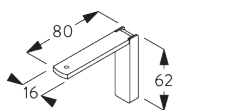

SG 11201

Smart Fix 80 mm

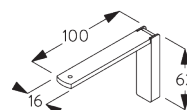

SG 11202

Smart Fix 100 mm

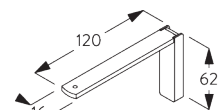

SG 11203

Smart Fix 120 mm

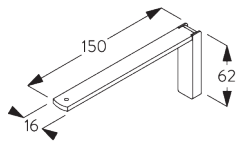

SG 11204
Smart Fix 150 mm

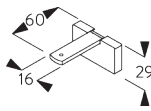

SG 11210
Smart Fix squadrato 60 mm

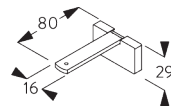

SG 11211
Smart Fix squadrato 80 mm

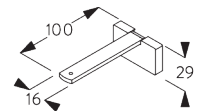

SG 11212
Smart Fix squadrato 100 mm

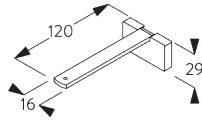

SG 11213
Smart Fix squadrato 120 mm

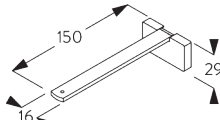

SG 11214
Smart Fix squadrato 150 mm

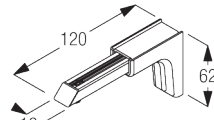

SG 11154
Smart fix universale 120 mm

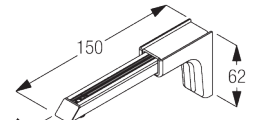

SG 11155
Smart fix universale 150 mm

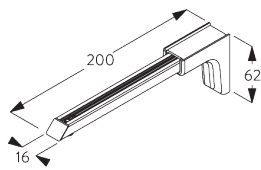

SG 11156
Smart fix universale 200 mm

D. FISSAGGIO A INCASSO

Profili a incasso SG 10172 - SG 10175

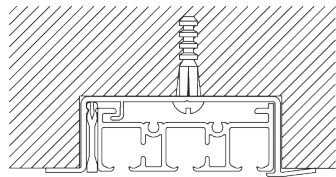

Uno spessore per profilo a incasso SG 10157 per ogni punto di fissaggio.

Per maggiori informazioni a riguardo del fissaggio a incasso, visitare il sito web Silent Gliss.

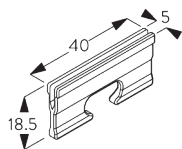

SG 10157
Spessore profilo incasso

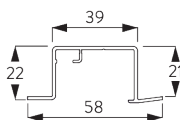

SG 10172
Profilo per incasso 10122

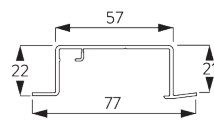

SG 10173
Profilo per incasso 10123

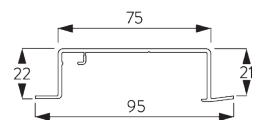

SG 10174
Profilo per incasso 10124

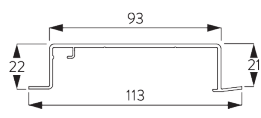

SG 10175
Profilo per incasso 10125

OPZIONI DEL SISTEMA

A. MOVIMENTAZIONE

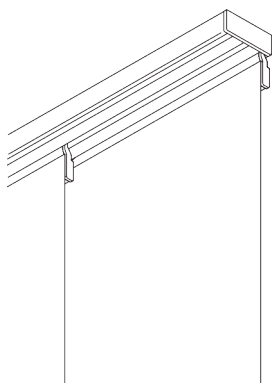

Pannelli liberi (non collegati)

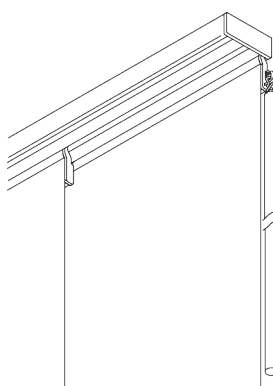

Pannelli collegati (asta guidatenda opzionale)

B. APERTURA DEI PANNELLI (COLLEGATI)



Apertura laterale
Nota: pallino = pannello fisso









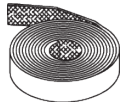
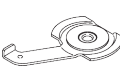

Apertura centrale
Nota: pallino = pannello fisso

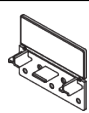

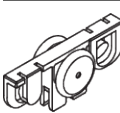







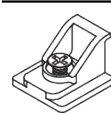

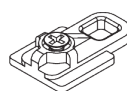

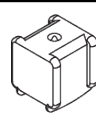
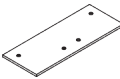
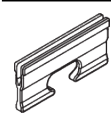

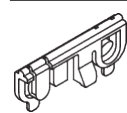
Sono possibili altre configurazioni

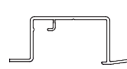
COMPONENTI

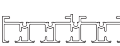
A. COMPONENTI STANDARD

	SG 2004 Profilo balza
	SG 2539 Nastro velcrato
	SG 3003 Supporto girevole
	SG 10123 Profilo a 3 vie
	SG 10143 Tappo profilo 3 vie
	SG 10159 Vite a testa svasata 3,5x13
	SG 10200 Scivolo a rullo rullo 2C
	SG 10230 Carrello in alluminio
	SG 10252 Tappo carrello sinistro
	SG 10253 Tappo carrello destro

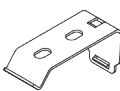
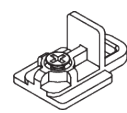
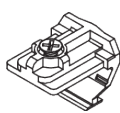
B. COMPONENTI OPTIONAL

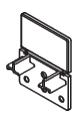
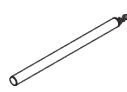
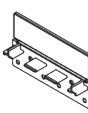
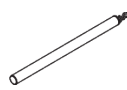
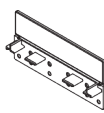
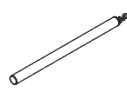
	SG 2005 Profilo balza		SG 10146 Angolo a L
	SG 3004 Supporto girevole		SG 10148 Aggancio asta
	SG 3008 Congiunzione		SG 10156 Fermo con vite
	SG 6024 Congiunzione		SG 10157 Spessore profilo incasso
	SG 10074 Vite a testa svasata M4x8		SG 10158 Scivolo click-in
	SG 10122 Profilo a 2 vie		SG 10172 Profilo per incasso 10122
	SG 10124 Profilo a 4 vie		SG 10173 Profilo per incasso 10123
	SG 10125 Profilo a 5 vie		SG 10174 Profilo per incasso 10124
	SG 10136 Supporto a scatto		SG 10175 Profilo per incasso 10125
	SG 10137 Supporto a scatto		SG 10340 Gancio per asta
	SG 10140 Angolo a T		SG 10395 Vite a testa cilindrica M4x6
	SG 10142 Tappo profilo 2 vie		SG 10430 Asta in alluminio 50 cm
	SG 10144 Tappo profilo 4 vie		SG 10431 Asta in alluminio 75 cm
	SG 10145 Tappo profilo 5 vie		SG 10432 Asta in alluminio 100 cm

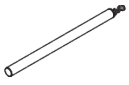

SG 10433

Asta in alluminio 125 cm

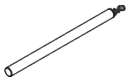

SG 10434

Asta in alluminio 150 cm

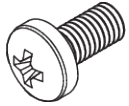

SG 10492

Vite a testa cilindrica M4x8

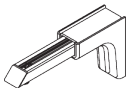

SG 11154

Smart fix univernale 120 mm

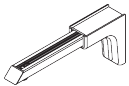

SG 11155

Smart fix univernale 150 mm

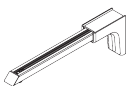

SG 11156

Smart fix univernale 200 mm

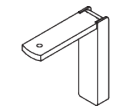

SG 11200

Smart Fix 60 mm

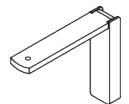

SG 11201

Smart Fix 80 mm

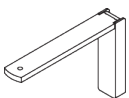

SG 11202

Smart Fix 100 mm

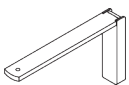

SG 11203

Smart Fix 120 mm



SG 11204

Smart Fix 150 mm

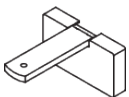

SG 11210

Smart Fix squadrato 60 mm

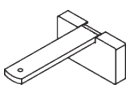

SG 11211

Smart Fix squadrato 80 mm

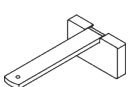

SG 11212

Smart Fix squadrato 100 mm

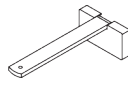

SG 11213

Smart Fix squadrato 120 mm

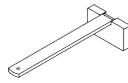

SG 11214

Smart Fix squadrato 150 mm