

SG 7600

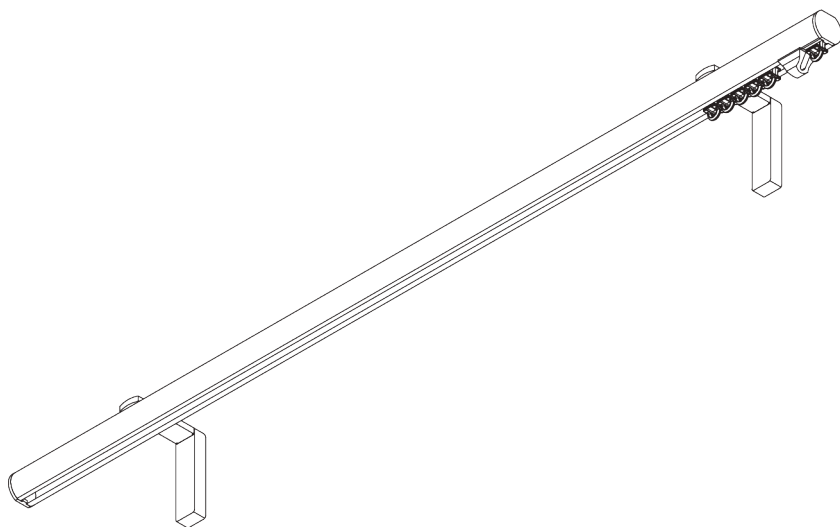
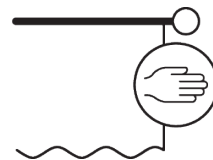

INFORMAZIONI SUL PRODOTTO

- **Movimentazione:** strappo
- **Range:** S
- **Fissaggio:** soffitto, parete
- **Finiture:** verniciato bianco RAL 9016, differenti colori/finiture
- **Tessuti:** Silent Gliss Collection

Caratteristiche:

- Scivolo a rullo con tecnologia a 2 componenti (2C)
- Wave (2C)
- Supporti, tappi e cover tappi abbinati
- Range di terminali decorativi
- Curvabile in piano

SPECIFICHE DEL SISTEMA

A. PROFILO

Profilo e informazioni di curvatura

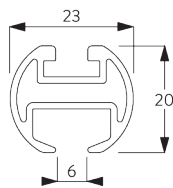

SG 11606

Profilo

Raggio:
✓ 15 cm, 20 cm, >25 cm

B. MISURE

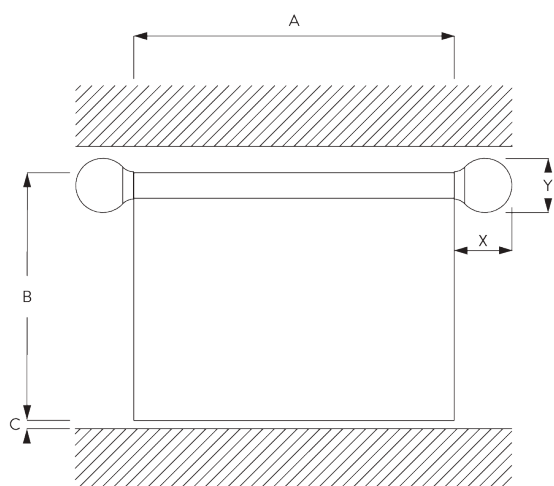

A: Larghezza sistema senza terminali







B: Altezza sistema

C: Distanza del tessuto dal pavimento

X: Larghezza terminale

Y: Altezza terminale

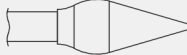
Misure terminale

		23 mm	
		X	Y
	SG 11602	2	23
	SG 11621	8	27
	SG 11622	14	38
	SG 11726	49	46
	SG 11727	89	37
	SG 11728	20	69
	SG 11729	18	46

INSTALLAZIONE

A. INFORMAZIONI DI FISSAGGIO

Per maggiori dettagli sul fissaggio, visita il sito web
Silent Gliss.

Punti di fissaggio

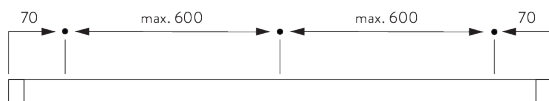

B. FISSAGGIO A SOFFITTO

Supporto top fix SG 11668

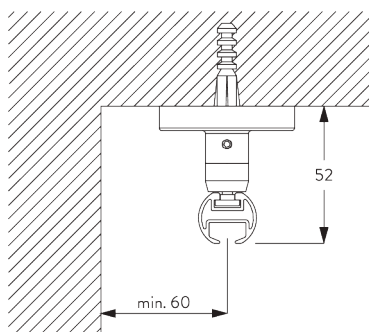

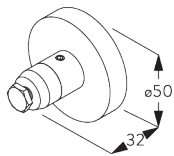

SG 11668

Supporto top fix

Mini tirante SG 6175

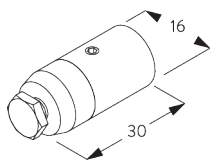
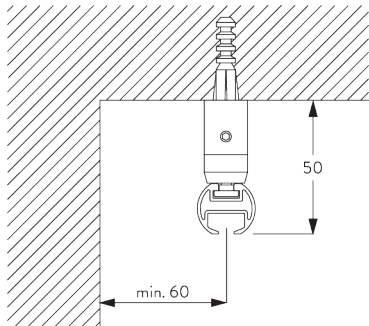

SG 6175

Tirante 3 cm

C. FISSAGGIO A PARETE

Smart Fix

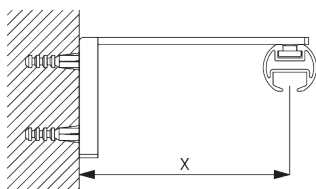

Smart Fix con asola SG 11206 - SG 11208 e SG 6141:

Necessaria vite SG 10492 (M4x8)

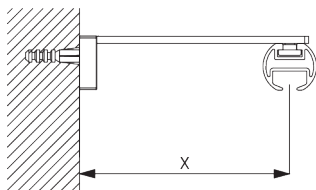

Smart Fix squadrato con asola SG 11216 - SG 11218 e SG 6141:

Necessaria vite SG 10492 (M4x8)

Smart Fix	X mm
SG 11206 / SG 11216	51
SG 11207 / SG 11217	71
SG 11208 / SG 11218	91

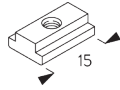

SG 6141

Parte di serraggio



SG 10492

Vite a testa cilindrica M4x8

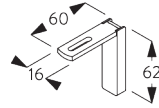

SG 11206

Smart Fix con asola 60 mm

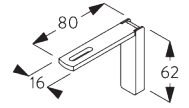

SG 11207

Smart Fix con asola 80 mm

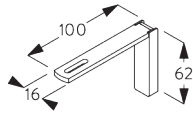

SG 11208

Smart Fix con asola 100 mm

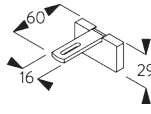

SG 11216

Smart Fix squadrato con asola 60 mm

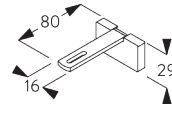

SG 11217

Smart Fix squadrato con asola 80 mm

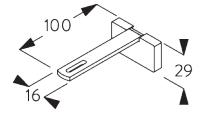

SG 11218

Smart Fix squadrato con asola 100 mm

Mensola SG 11669

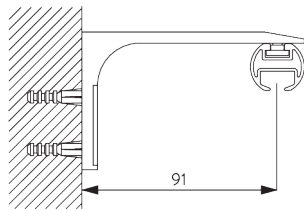

Necessaria vite SG 10492 (M4x8).

Consigliato unicamente per sistemi lineari.

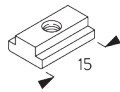

SG 6141

Parte di serraggio



SG 10492

Vite a testa cilindrica M4x8

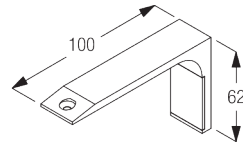

SG 11669

Mensola

DESIGN & OPZIONI DEL SISTEMA

A. TAPPI



SG 11602



SG 11621



SG 11622

Tappi:

- SG 11602 Tappo a filo 23 mm
- SG 11621 Cover tappo 23 mm
- SG 11622 Tappo design 23 mm

Nota:

- Senza terminali, i profili vengono forniti di default con tappi a filo abbinati SG 11602 (sinistra).
- In alternativa, le cover tappi SG 11621 possono essere scelte senza supplemento.

B. TERMINALI

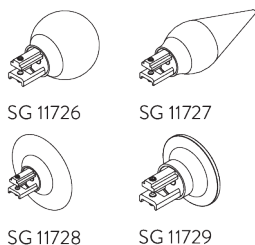

I terminali sono elementi decorativi che vengono installati alle estremità del profilo:

- SG 11726 Sfera 23 mm
- SG 11727 Lancia 23 mm
- SG 11728 Ellisse 23 mm
- SG 11729 Cono 23 mm

C. WAVE

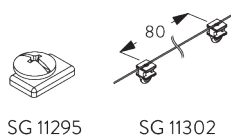
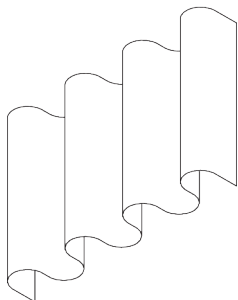

Componenti standard:

- SG 11295 Vite di arresto
- SG 11302 Scivolo a pattino Wave 2C 80 mm

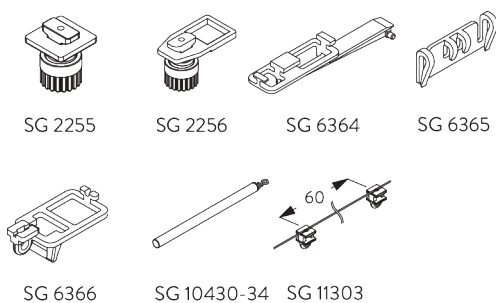

Componenti opzionali (raggio minimo >25 cm):

- SG 2255 Freno
- SG 2256 Freno
- SG 6364 Estensione Wave
- SG 6365 Gancio Wave
- SG 6366 Scivolo Wave per asta
- SG 10430 Asta
- SG 11303 Scivolo a pattino Wave 2C 60 mm

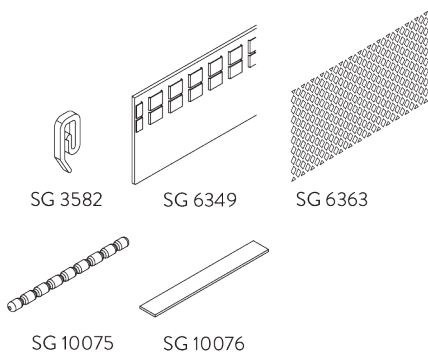

Componenti per tende:

- SG 3582 Gancio
- SG 6349 Fettuccia tenda Wave
- SG 6363 Fettuccia termosaldabile Wave
- SG 10075 Peso in piombo 50 gr/m
- SG 10076 Peso in tessuto

Wave: ingombro tenda impacchettata (componenti standard)

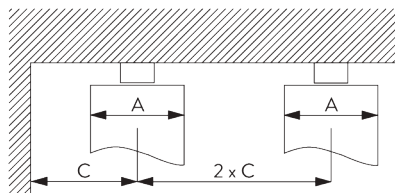
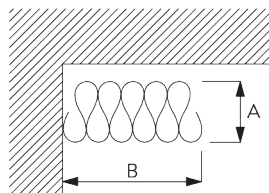

A = Ingombro in profondità
B = Ingombro in larghezza
C = Min. distanza

Scivoli rullo/pattino SG 11302	Tasche tra i ganci	Ricchezza tenda approx.	Ingombro in profondità A	Ingombro in larghezza B*	Min. distanza C
80	6	~2.1	140	180 per metro di sistema	90
80	7	~2.3	160	180 per metro di sistema	100

Scivoli rullo/pattino SG 11303	Tasche tra i ganci	Ricchezza tenda approx.	Ingombro in profondità A	Ingombro in larghezza B*	Min. distanza C
60	4	~2.1	100	230 per metro di sistema	70
60	5	~2.3	120	230 per metro di sistema	80

*L'ingombro in larghezza B aumenta di 95 mm quando si utilizza il carrello di estensione Wave

COMPONENTI

A. COMPONENTI STANDARD



SG 6065

Arresto con occhio



SG 6141

Parte di serraggio

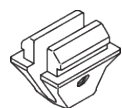

SG 6245

Molla di chiusura



SG 10492

Vite a testa cilindrica M4x8

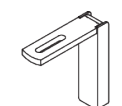

SG 11206

Smart Fix con asola 60 mm



SG 11300

Scivolo 2C

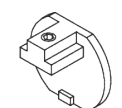

SG 11602

Tappo a filo 23 mm



SG 11606

Profilo

B. COMPONENTI OPTIONAL

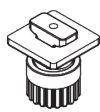

SG 2255

Freno

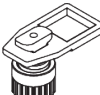

SG 2256

Freno



SG 3582

Gancio a G



SG 3599

Gancio doppio

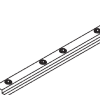

SG 6173

Ponte di connessione

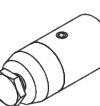

SG 6175

Tirante 3 cm



SG 6349

Fettuccia wave



SG 6363

Fettuccia termosaldabile

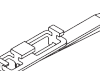

SG 6364

Carrello wave

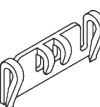

SG 6365

Gancio wave

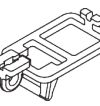

SG 6366

Scivolo pilota wave con aggancio



SG 10075

Piombo 50 g/m



SG 10076

Piattina peso



SG 10430

Asta in alluminio 50 cm

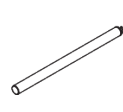

SG 10431

Asta in alluminio 75 cm

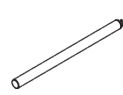

SG 10432

Asta in alluminio 100 cm

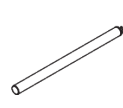

SG 10433

Asta in alluminio 125 cm

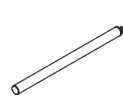

SG 10434

Asta in alluminio 150 cm

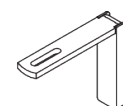

SG 11207

Smart Fix con asola 80 mm

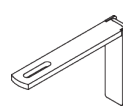

SG 11208

Smart Fix con asola 100 mm

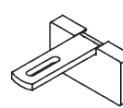

SG 11216

Smart Fix squadrato con asola 60 mm

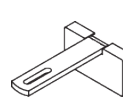

SG 11217

Smart Fix squadrato con asola 80 mm

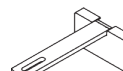

SG 11218

Smart Fix squadrato con asola 100 mm

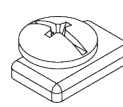

SG 11295

Fermo con vite



SG 11301

Scivolo 2C in matarozza

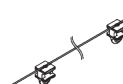

SG 11302

Scivoli a pattino 2C wave 80 mm

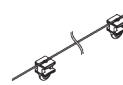

SG 11303

Scivoli a pattino 2C wave 60 mm



SG 11621

Cover tappo 23 mm

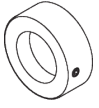

SG 11622

Tappo design 23 mm



SG 11668

Supporto top fix

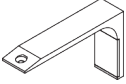

SG 11669

Mensola

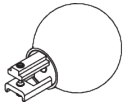

SG 11726

Sfera 23 mm

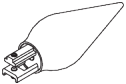

SG 11727

Lancia 23 mm

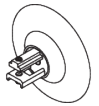

SG 11728

Ellisse 23 mm

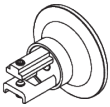

SG 11729

Cono 23 mm
