

SG 2190

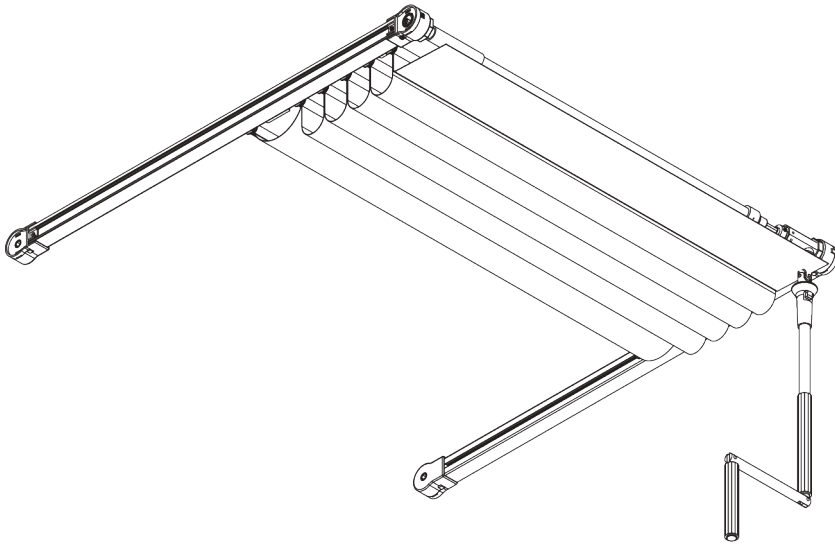
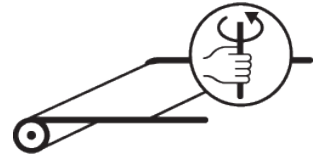

INFORMAZIONI SUL PRODOTTO

- **Movimentazione:** manovella
- **Range:** S - M
- **Fissaggio:** soffitto, parete
- **Finiture:** verniciato bianco RAL 9016 o argento anodizzato, altri RAL su richiesta
- **Tessuti:** Silent Gliss Collection

Caratteristiche:

- Curvabile
- Adatto per applicazioni inclinate
- Versione a sbalzo
- Fino a 2 sistemi collegati

SPECIFICHE DEL SISTEMA

A. DIMENSIONI DEL SISTEMA

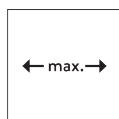

2.5 m
(più 0,8 m per lato per lo sbalzo)

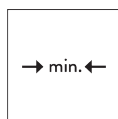

60 cm

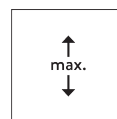

6 m



15 kg

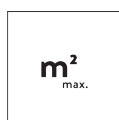

15 m²

Dimensione e portata massimi del sistema - sistemi lineari

SG 2190		A (m)		B (m)		kg _{max.}	m ² _{max.}
		Type 1	Type 2/3	Type 1	Type 2/3		
		1.8	1.8	5	5	15	9
		0.9 / 0.9	0.9 / 0.9	5	5	15	9
		2	2	5	5	15	10
		1/1	1/1	5	5	15	10
		2.5	2.5	6	6	15	15
		1.5 / 1.5	1.5 / 1.5	6	6	15	18

Sistemi piegati

SG 2190		A (m)		B (m)		kg _{max.}	m ² _{max.}
		Type 1	Type 2/3	Type 1	Type 2/3		
		2	2	5	5	15	10
		1/1	1/1	5	5	15	10
		2	2	5	5	15	10
		1/1	1/1	4	4	15	8
		2	2	4	4	10	8
		1/1	1/1	4	4	10	8

B. PROFILO

Profilo e informazioni di curvatura

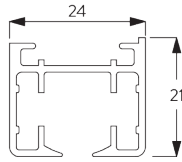

SG 2191

Profilo

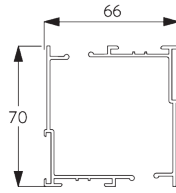

SG 2151

Profilo

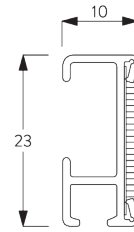

SG 2116

Profilo veltrato

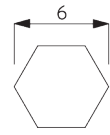

SG 2111

Alberino esagonale

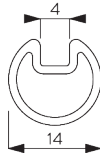

SG 2156

Alberino

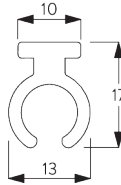

SG 2231

Profilo



SG 2246

Tondino PVC e 5 mm

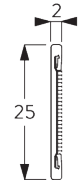

SG 2510

Carrello alluminio veltrato



SG 2759

Profilo

C. MISURE

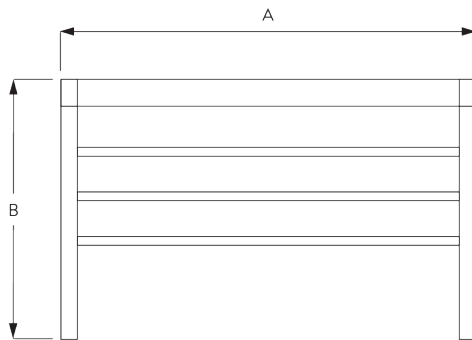

A: Larghezza sistema
B: Altezza sistema

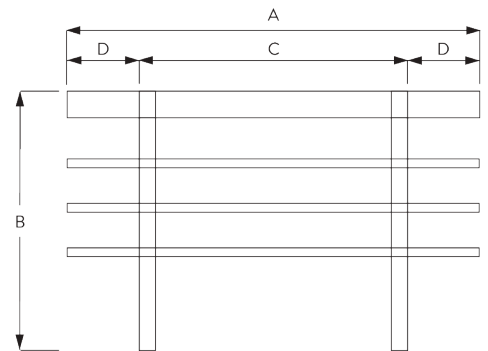

A: Larghezza sistema
B: Altezza sistema
C: Sistema di base
D: Sbalzo max. 80 cm

INSTALLAZIONE

A. INFORMAZIONI DI FISSAGGIO

Per maggiori dettagli sul fissaggio, visita il sito web
Silent Gliss.

Punti di fissaggio

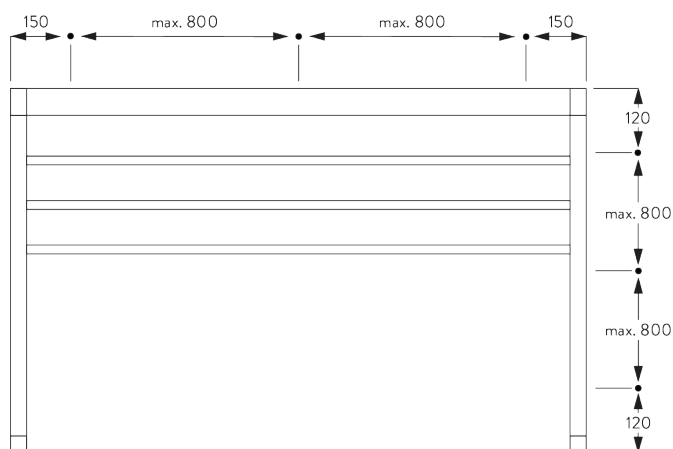

B. FISSAGGIO NEL VANO

Supporto girevole
SG 3825

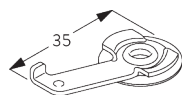
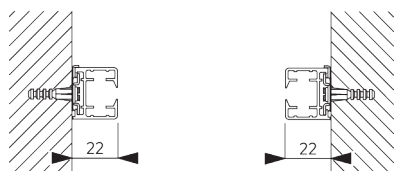

SG 3825

Supporto girevole

C. FISSAGGIO FRONTALE

Supporto girevole
SG 3181 / SG 3182

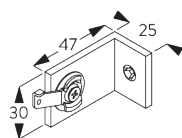
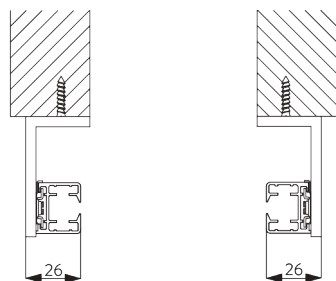

SG 3181

Supporto con girevole

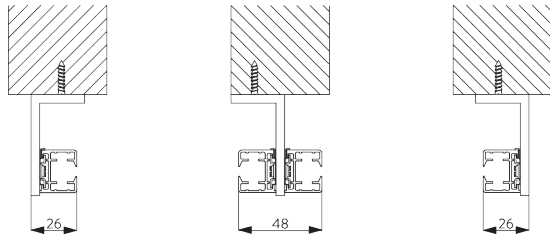

Sistema doppio

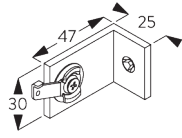

SG 3181

Supporto con girevole

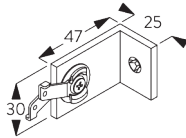

SG 3182

Supporto con 2 girevoli

OPZIONI DEL SISTEMA

A. DUE SISTEMI CONNESSI

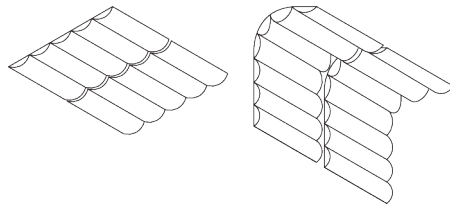

B. OPZIONI DI INSTALLAZIONE

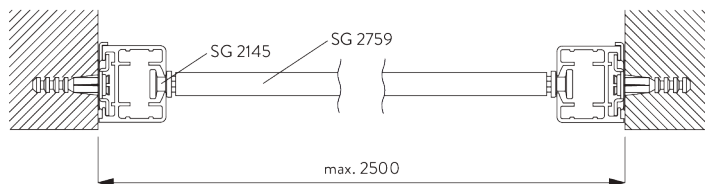

Tipo 1

- SG 2145: scivolo
- SG 2759: profilo

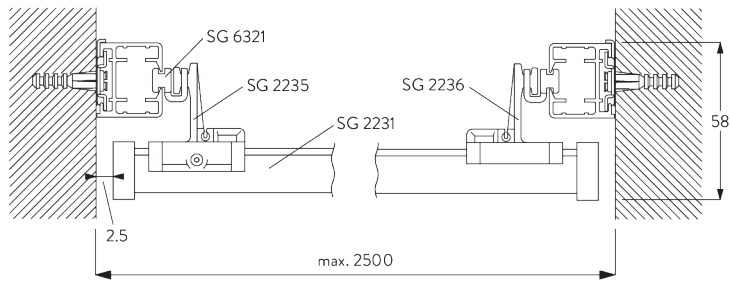

Tipo 2 (Profili coperti)

- SG 2231: profilo
- SG 2235: scivolo con vite
- SG 2236: scivolo senza vite
- SG 6321: scivolo

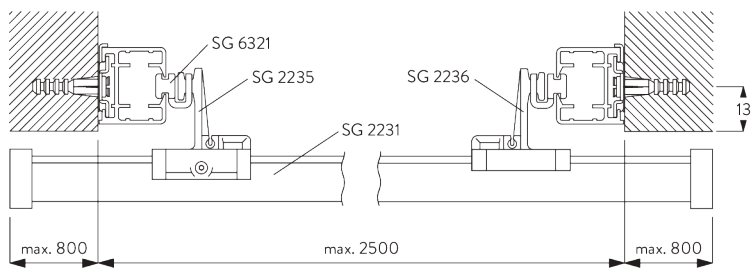

Tipo 3 (Versione a sbalzo per coprire i profili laterali)

- SG 2231: profilo
- SG 2235: scivolo con vite
- SG 2236: scivolo senza vite
- SG 6321: scivolo

**C. FISSAGGIO DEL
TESSUTO**

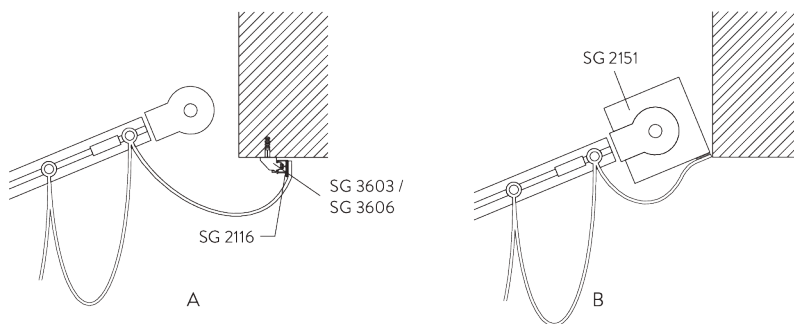



A: Fissaggio del tessuto tramite profilo SG 2116 (standard)

B: Fissaggio del tessuto direttamente sul profilo piatto inserito nel cassonetto



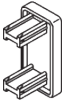
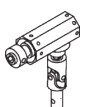
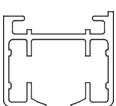
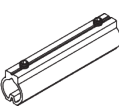
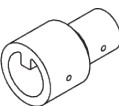
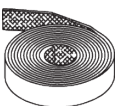

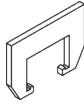
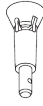
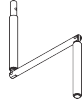
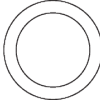
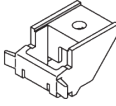
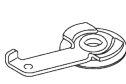
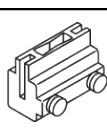
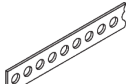
COMPONENTI

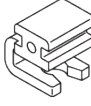
A. COMPONENTI STANDARD

	SG 2111 Alberino esagonale
	SG 2116 Profilo velcrato
	SG 2131 Tappo profilo
	SG 2145 Scivolo per inserto 13 mm
	SG 2156 Alberino
	SG 2182 Bussola per asta
	SG 2189 Comando argano
	SG 2191 Profilo
	SG 2192 Guida di comando argano
	SG 2193 Guida di ritorno ritorno
	SG 2230 Guida di comando
	SG 2242 Connettore
	SG 2244 Raccordo
	SG 2539 Nastro velcrato

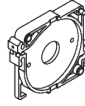
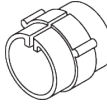
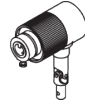
	SG 2613 Congiunzione banda
	SG 2754 Bicchierino asta asportabile
	SG 2756 Manovella snodabile
	SG 2759 Profilo
	SG 3603 Supporto a soffitto
	SG 3825 Supporto girevole
	SG 5005 Scivolo terminale banda
	SG 5130 Banda di trascinamento
	SG 6086 Molla di chiusura
	SG 6321 Scivolo per inserto

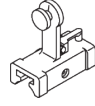
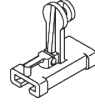
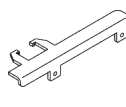
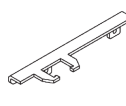
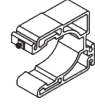
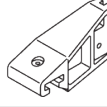
B. COMPONENTI OPTIONAL

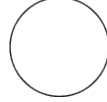
	SG 2151 Profilo
	SG 2152 Calotta avvolginastro
	SG 2153 Rullino avvolginastro
	SG 2176 Comando argano
	SG 2181 Supporto per 2176
	SG 2231 Profilo
	SG 2235 Scivolo sinistro
	SG 2236 Scivolo destro
	SG 2237 Carrello di sormonto destro
	SG 2238 Carrello di sormonto sinistro
	SG 2239 Supporto guida
	SG 2241 Supporto lungo carrello di sormonto
	SG 2243 Tappo inserto
	SG 2246 Tondino PVC ø 5 mm

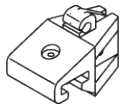

SG 2249

Supporto carrello di sormonto



SG 2510

Carrello alluminio velcrato



SG 2742

Snodo asta fissa



SG 3004

Supporto girevole

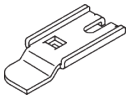

SG 3041

Supporto

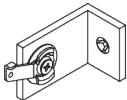

SG 3181

Supporto con girevole

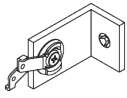

SG 3182

Supporto con 2 girevoli



SG 3606

Supporto bottone

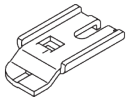

SG 3832

Supporto per mensole

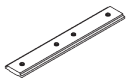

SG 5115

Congiunzione

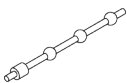

SG 6322

Catenella distanziatrice inserti

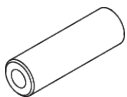

SG 6796

Spina elastica 4x12 DIN 1481